

# GNSS Satellite Orbit Modelling Theory and Practice

R. Dach  
and the Satellite Geodesy research group

*Astronomical Institute, University of Bern, Switzerland*

NGK Summer School  
29. August – 01. September 2016, Båstad, Sweden

# Overview

---

Introduction and Motivation

Overview on the GNSS Constellations

Effects Acting on Satellites and Related Models

Precise Orbit Determination for GNSS Satellites

GNSS Orbit Determination within the IGS



# Effect of Orbit Errors on GNSS Solutions

---

## Errors in baseline components due to orbit errors

following Bauršima, 1983:

$$\Delta X_l(\text{m}) \approx \frac{l}{d} \cdot \Delta X_{ORB}(\text{m}) \approx \frac{l(\text{km})}{25'000(\text{km})} \cdot \Delta X_{ORB}(\text{m})$$

# Effect of Orbit Errors on GNSS Solutions

## Errors in baseline components due to orbit errors

following Bauršima, 1983:

$$\Delta X_l(\text{m}) \approx \frac{l}{d} \cdot \Delta X_{ORB}(\text{m}) \approx \frac{l(\text{km})}{25'000(\text{km})} \cdot \Delta X_{ORB}(\text{m})$$

Orbit Error $\Delta X_{ORB}$	Baseline Length $l$	Baseline Error $\frac{\delta X_{ORB}}{25'000 \text{ km}}$	Baseline Error $\Delta X_l$
2.5 m	1 km	0.1 ppm	—
2.5 m	10 km	0.1 ppm	1 mm
2.5 m	100 km	0.1 ppm	10 mm
2.5 m	1000 km	0.1 ppm	100 mm
0.05 m	1 km	0.002 ppm	—
0.05 m	10 km	0.002 ppm	—
0.05 m	100 km	0.002 ppm	0.2 mm
0.05 m	1000 km	0.002 ppm	2 mm

# Effect of Orbit Errors on GNSS Solutions

## Errors in baseline components due to orbit errors

Daily Repeatabilities of Latitude, Longitude, Height of the Baseline Onsala—Graz (from 8.9.94 – 8.12.94) Using Broadcast Orbits

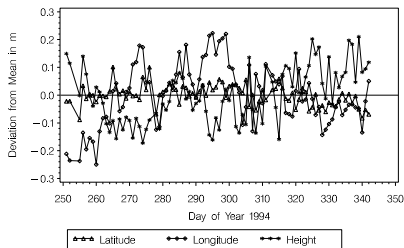

Daily Repeatabilities of Latitude, Longitude, Height of the Baseline Onsala—Graz (from 8.9.94 – 8.12.94) Using IGS Orbits

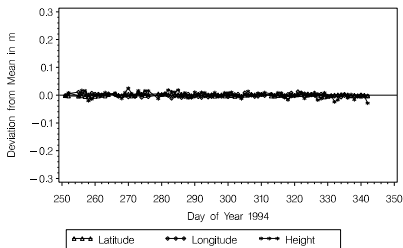

Repeatability (north, east, up) when processing 90 days of GPS observations at Graz (Austria) and Onsala (Sweden) (1200 km baseline) with **broadcast orbits** (left) and with **IGS orbits** (right).

# GNSS: Global Navigation Satellite Systems

---



**USA:** GPS

Global Positioning System

# GNSS: Global Navigation Satellite Systems

---



**USA:** GPS

Global Positioning System



**Russia:** ГЛОНАСС

Глобальная навигационная спутниковая система

# GNSS: Global Navigation Satellite Systems

---



**USA:** GPS

Global Positioning System



**Russia:** GLONASS

Global Satellite Navigation System

# GNSS: Global Navigation Satellite Systems

---



**USA:** GPS

Global Positioning System



**Russia:** GLONASS

Global Satellite Navigation System



**Europe:** Galileo

# GNSS: Global Navigation Satellite Systems

---



**USA:** GPS

Global Positioning System



**Russia:** GLONASS

Global Satellite Navigation System

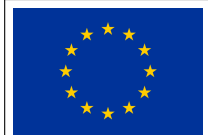

**Europe:** Galileo



**P.R. of China:** BeiDou



# GPS Constellation

## NAVSTAR GPS Block IIF Satellites



Approximate dimensions:

bus:  $2 \times 2 \times 2.5$  m

solar panels:  $3 \times 2.5 \times 2$  m

mass at launch:  $\approx 1.6$  t



Pictures from the manufacturer Boeing and [www.gps.gov](http://www.gps.gov).

## Fact sheet

### Orbital elements for GPS satellites

$a$ : 26 560 km

$e$ : 0 (circular orbit)

$i$ : 55°

### Distribution of orbital planes

Number 6 separated by  $\Omega_i = \Omega_0 + n \cdot 60^\circ$   
Satellites 4 unequally distributed  
= 24 nominal constellation (today 32 active)

# GPS Constellation

---

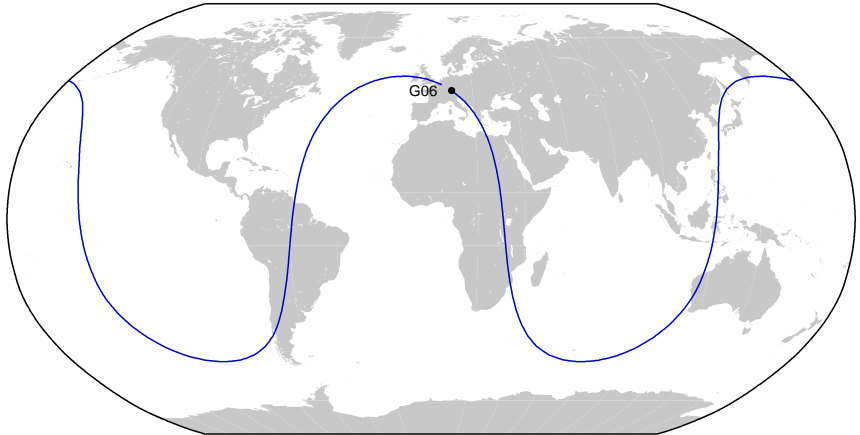

G06 for 1 day (09-May-2012)

# GPS Constellation

---

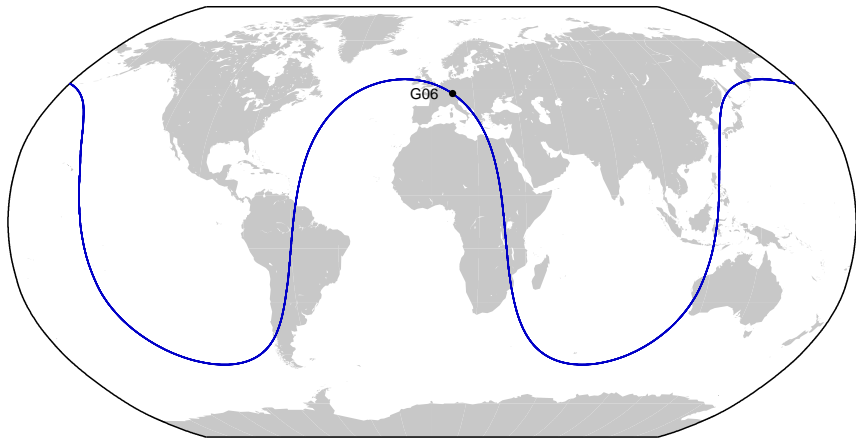

G06 for 10 days (from 09-May-2012 to 18-May-2012)

# GPS Constellation

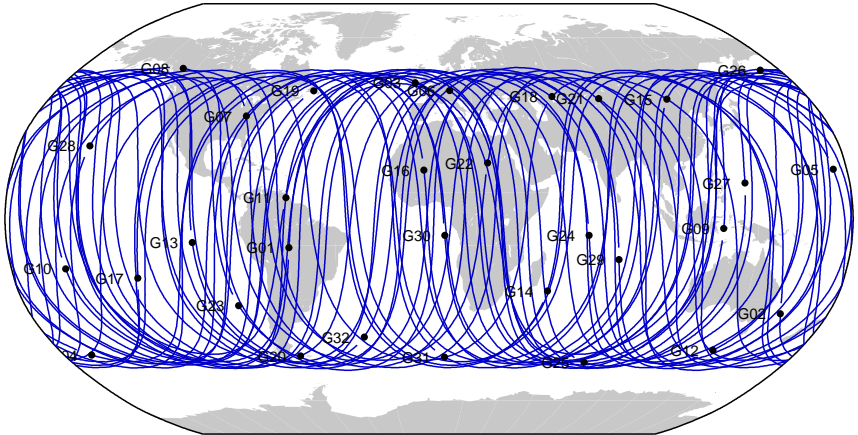

All GPS-satellites for 10 days (from 09-May-2012 to 18-May-2012)

# GPS Constellation

- Revolution period  $11^{\text{h}} 58^{\text{m}}$   
(same constellation after 2 revolutions within 1 sidereal day)

Elevation–Azimuth–Diagram  
for Zimmerwald

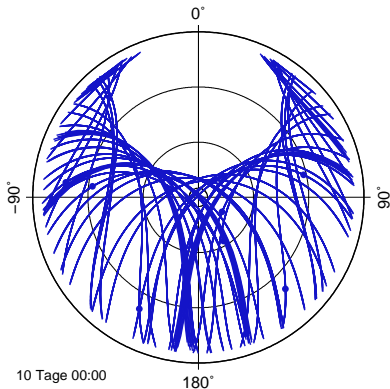

# GPS Constellation

- Revolution period  $11^{\text{h}} 58^{\text{m}}$   
(same constellation after 2 revolutions within 1 sidereal day)
- Repetition rates:  
same geometry: 1 sidereal day  
same constellation: 1 sidereal day

Elevation–Azimuth–Diagram  
for Zimmerwald

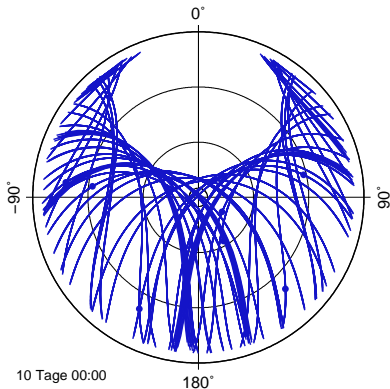

# GPS Constellation

- Revolution period  $11^{\text{h}} 58^{\text{m}}$   
(same constellation after 2 revolutions within 1 sidereal day)
- Repetition rates:  
same geometry: 1 sidereal day  
same constellation: 1 sidereal day
- Signals:  
Code: C1,  
          P1, P2,  
Phase: L1, L2

GPS Constellation

21-Aug-2016

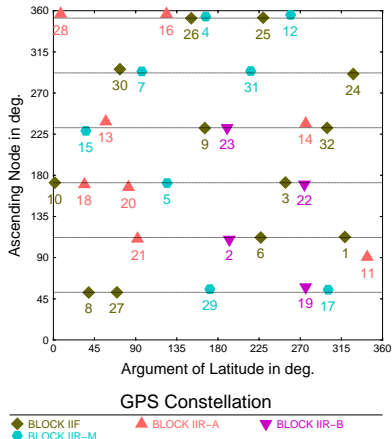



# GPS Constellation

- Revolution period  $11^{\text{h}} 58^{\text{m}}$   
(same constellation after 2 revolutions within 1 sidereal day)
- Repetition rates:  
same geometry: 1 sidereal day  
same constellation: 1 sidereal day
- Signals:  
Code: C1, C2 (since IIR-M),  
P1, P2,  
Phase: L1, L2 (L2C!!)

GPS Constellation

21-Aug-2016

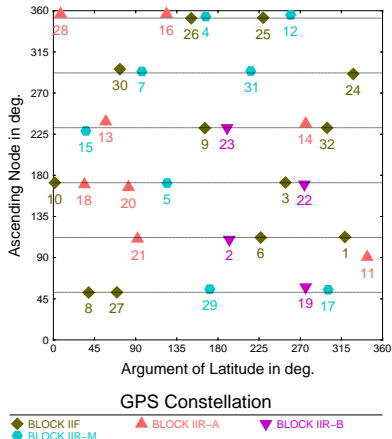

# GPS Constellation

- Revolution period  $11^{\text{h}} 58^{\text{m}}$   
(same constellation after 2 revolutions within 1 sidereal day)
- Repetition rates:  
same geometry: 1 sidereal day  
same constellation: 1 sidereal day
- Signals:  
Code: C1, C2 (since IIR-M),  
P1, P2, C5 (since IIF)  
Phase: L1, L2 (L2C!!), L5

GPS Constellation

21-Aug-2016

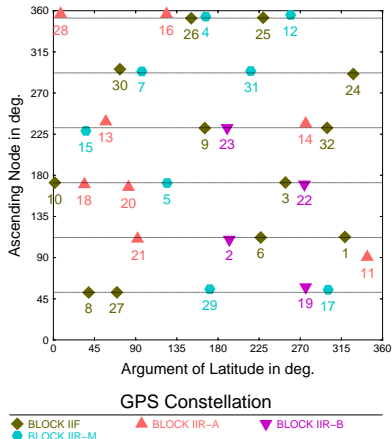

# GLONASS Constellation

## GLONASS-M Satellites



Approximate dimensions:  
bus: cylinder  $2.4 \times 3.7$  m  
solar panels: width of 7.2 m  
mass at launch:  $\approx 1.5$  t



Pictures from <http://cdn.satellitetoday.com> and <http://newspepper.su>.

# GLONASS Constellation

---

## Fact sheet

### Orbital elements for GLONASS satellites

$a$ : 25 500 km

$e$ : 0 (circular orbit)

$i$ :  $65^\circ$

### Distribution of orbital planes

Number	3	separated by $\Omega_i = \Omega_0 + n \cdot 120^\circ$
Satellites	8	equally distributed
	= 24 nominal constellation	

# GLONASS Constellation

---

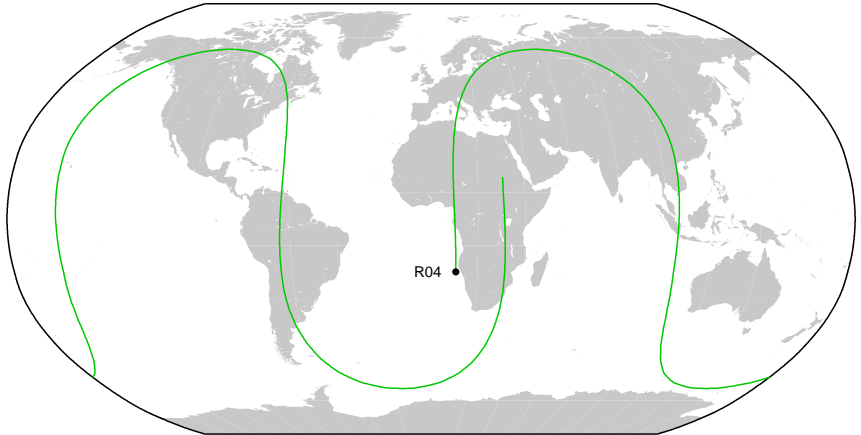

R04 for 1 day (09-May-2012)

# GLONASS Constellation

---

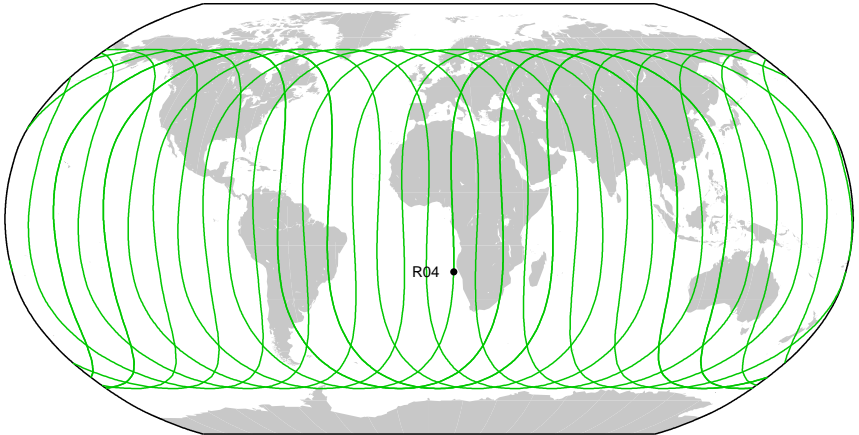

R04 for 10 days (from 09-May-2012 to 18-May-2012)

# GLONASS Constellation

---

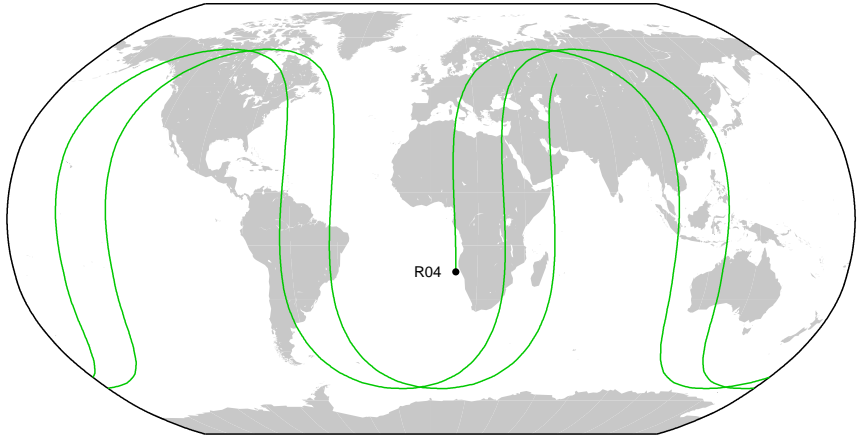

R04 for 2 days (from 09-May-2012 to 10-May-2012)

# GLONASS Constellation

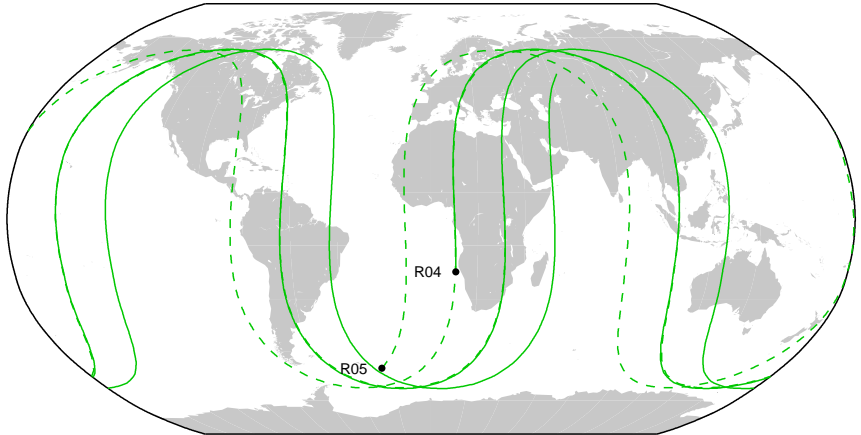

R04 and R05 for 2 days (from 09-May-2012 to 10-May-2012)



# GLONASS Constellation

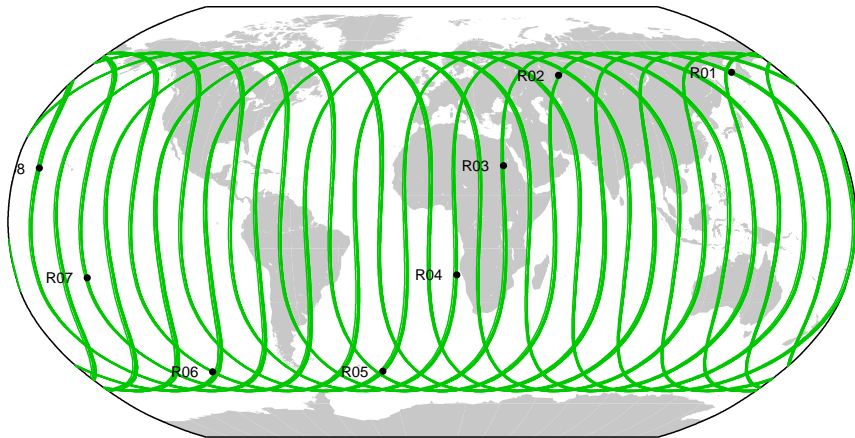

R01 to R08 for 10 days (from 09-May-2012 to 18-May-2012)

# GLONASS Constellation

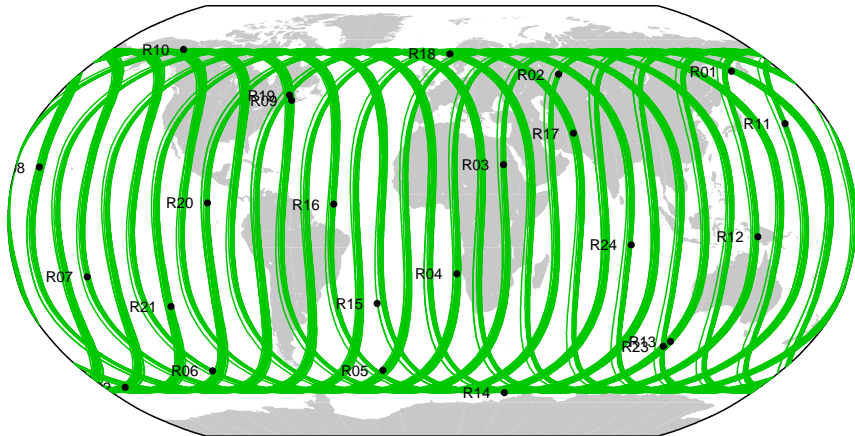

All GLONASS satellites for 10 days (from 09-May-2012 to 18-May-2012)

# GLONASS Constellation

- Revolution period  $11^{\text{h}} 16^{\text{m}}$   
(same constellation after 17 revolutions within 8 sidereal days)

Elevation–Azimuth–Diagram  
for Zimmerwald

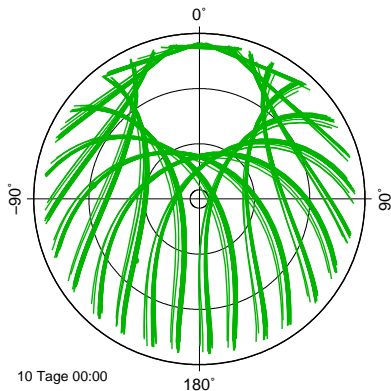

# GLONASS Constellation

- Revolution period  $11^{\text{h}} 16^{\text{m}}$   
(same constellation after 17 revolutions within 8 sidereal days)
- Repetition rates:  
same geometry:
  - same plane: 1 sidereal day
  - next plane:  $\frac{1}{3}$  sidereal daysame constellation: 8 sidereal days

Elevation–Azimuth–Diagram  
for Zimmerwald

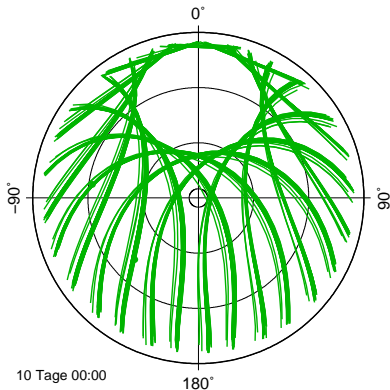

# GLONASS Constellation

- Revolution period  $11^h 16^m$   
(same constellation after 17 revolutions within 8 sidereal days)
- Repetition rates:  
same geometry:
  - same plane: 1 sidereal day
  - next plane:  $\frac{1}{3}$  sidereal daysame constellation: 8 sidereal days
- Signals:  
Code: C1, C2, P1, P2  
Phase: L1, L2

GLONASS Constellation 21-Aug-2016

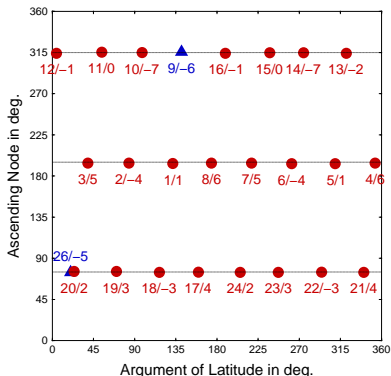

▲ GLONASS-K1 ● GLONASS-M

# Galileo Constellation

## Galileo FOC Satellites

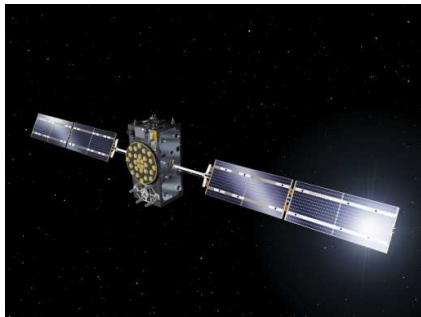
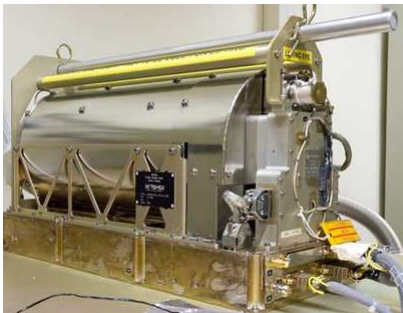

Approximate dimensions:

bus:  $2.5 \times 1.1 \times 1.2$  m; solar panels: width tip-to-tip 14.5 m

Mass at launch:  $\approx 733$  kg

Pictures from ESA downloaded from <http://spaceflight101.com>.

# Galileo Constellation

---

## Fact sheet

### Orbital elements for Galileo satellites

$a$ :	30 000 km	
$e$ :	0	(circular orbit)
$i$ :	$56^\circ$	

### Distribution of orbital planes

Number	3	separated by $\Omega_i = \Omega_0 + n \cdot 120^\circ$
Satellites	9	equally distributed
	= 27 nominal constellation	

# Galileo Constellation

- Revolution period  $13^{\text{h}} 45^{\text{m}}$   
(same constellation after 17 revolutions within 10 sidereal days)

Galileo Constellation

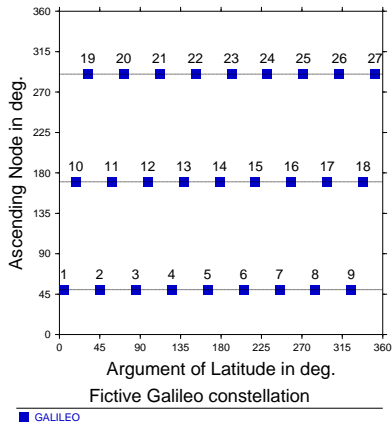



# Galileo Constellation

- Revolution period  $13^{\text{h}} 45^{\text{m}}$   
(same constellation after 17 revolutions within 10 sidereal days)
- Repetition rates:  
same geometry/constellation:  
10 sidereal days

Galileo Constellation

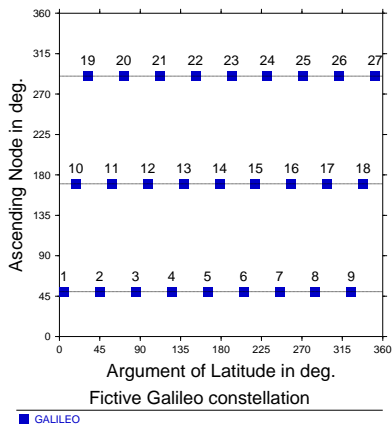

# Galileo Constellation

- Revolution period  $13^{\text{h}} 45^{\text{m}}$   
(same constellation after 17 revolutions within 10 sidereal days)
- Repetition rates:  
same geometry/constellation:  
10 sidereal days

Galileo Constellation

21-Aug-2016

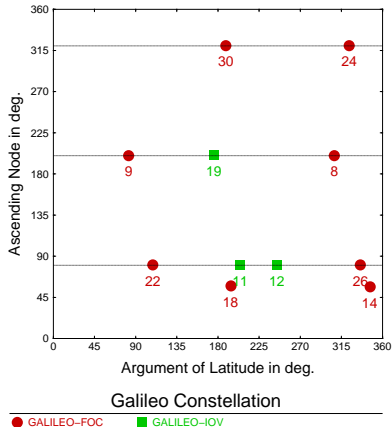

# Galileo Constellation

---

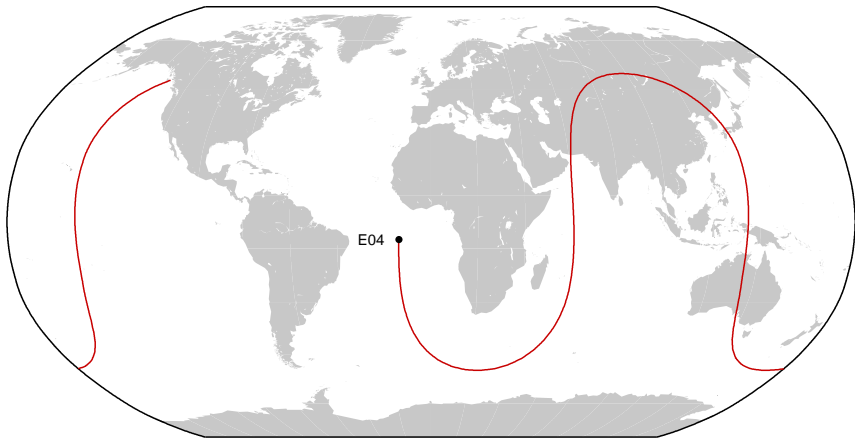

Fictive E04 for one day

# Galileo Constellation

---

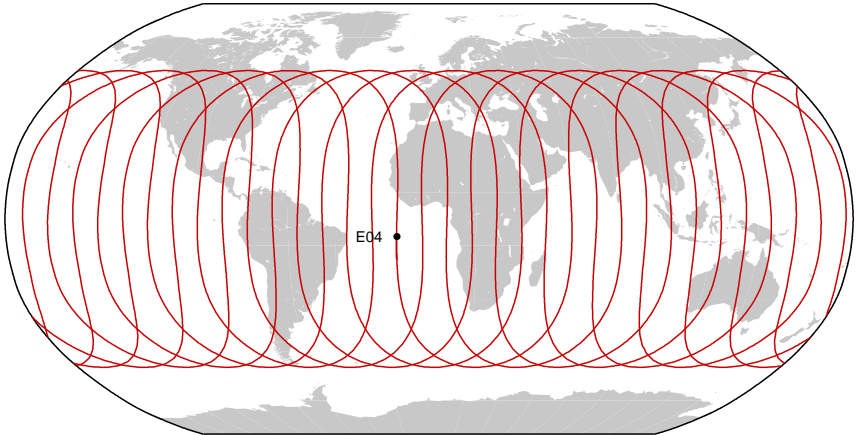

Fictive E04 for 10 days

# Galileo Constellation

---

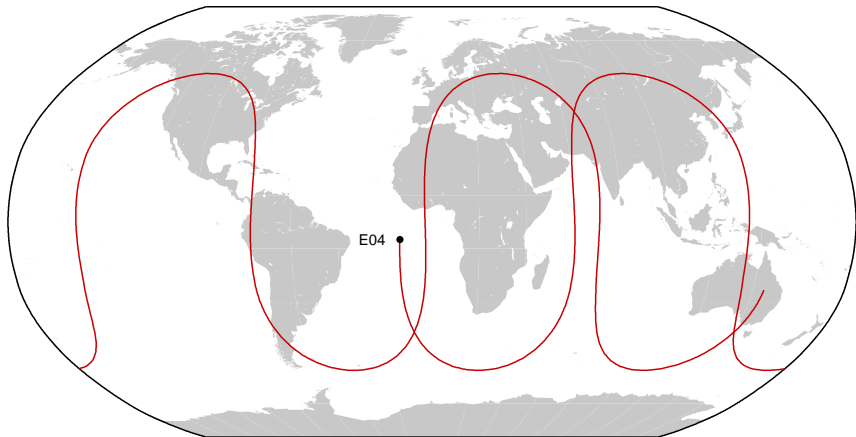

Fictive E04 for two days

# Galileo Constellation

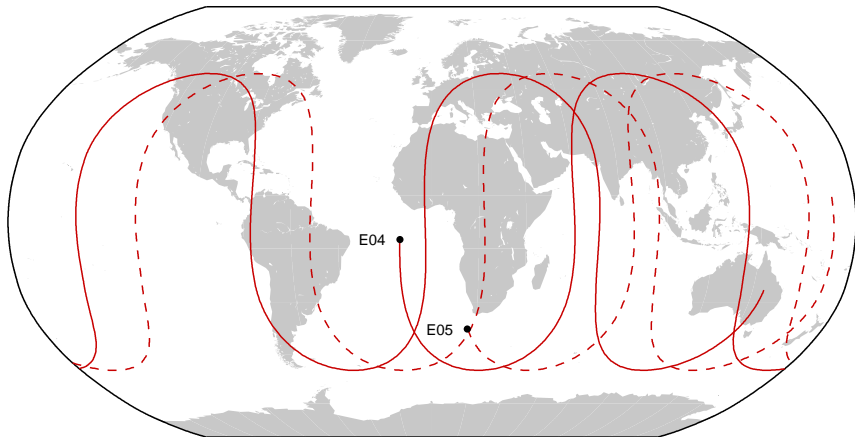

Fictive E04 and E05 for two days

# Galileo Constellation

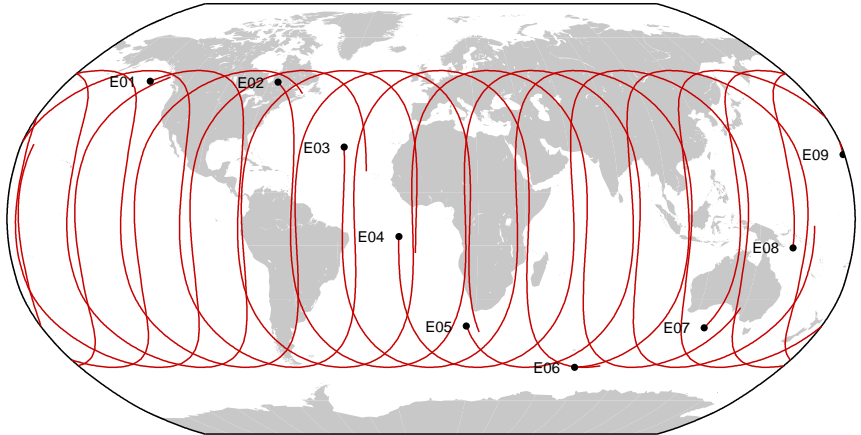

Fictive E01 to E09 for two days

# Galileo Constellation

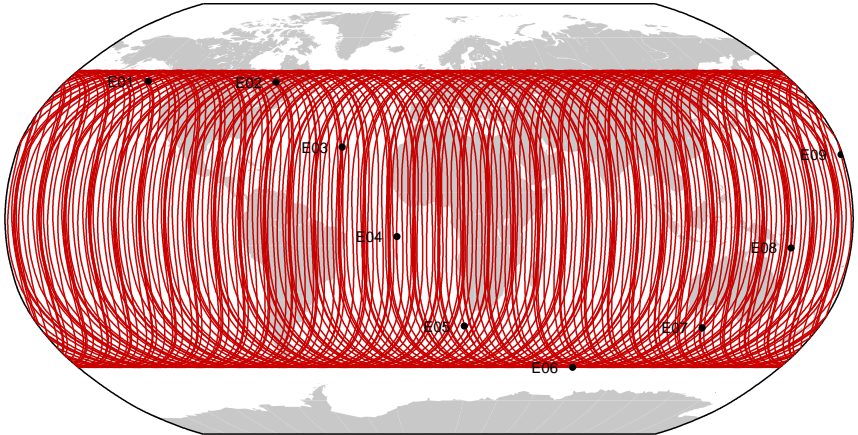

Fictive E01 to E09 for 10 days



# Galileo Constellation

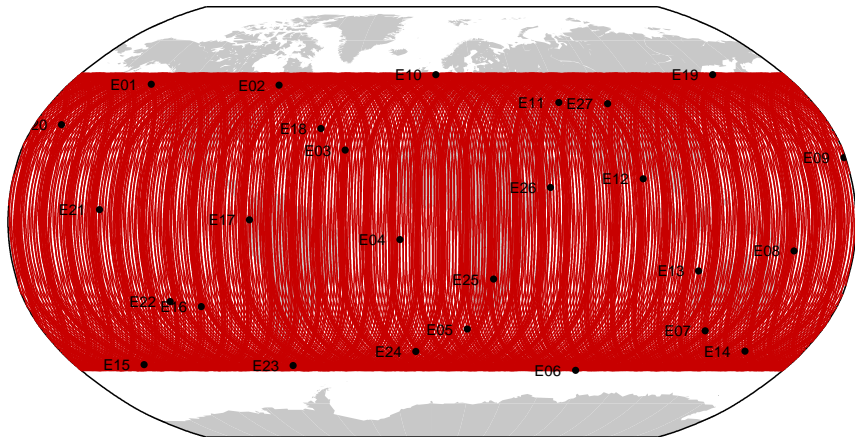

Fictive Galileo constellation for 10 days

# BeiDou Constellation

---

## Fact sheet (MEO)

### Orbital elements for BeiDou satellites

$a$ : 28 000 km

$e$ : 0 (circular orbit)

$i$ :  $55^\circ$

### Distribution of orbital planes

Number	3	separated by $\Omega_i = \Omega_0 + n \cdot 120^\circ$
Satellites	9	equally distributed
	= 27 nominal constellation	

# BeiDou Constellation

---

## Fact sheet (MEO)

### Orbital elements for BeiDou satellites

$a$ : 28 000 km

$e$ : 0 (circular orbit)

$i$ :  $55^\circ$

### Distribution of orbital planes

Number 3 separated by  $\Omega_i = \Omega_0 + n \cdot 120^\circ$

Satellites 9 equally distributed  
= 27 nominal constellation

### Repetition rates

Revolution period 12 h 57 min

Constellation after 17 revolutions within 7 sidereal days

# BeiDou Constellation

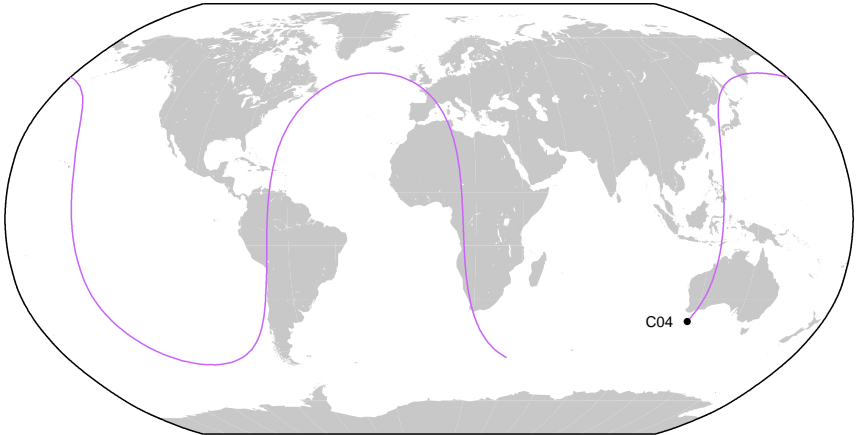

R. Dach: GNSS Satellite Orbit Modelling  
NGK Summer School, 29. Aug.–01. Sep. 2016, Bästäd

Fictive C04 for one day

# BeiDou Constellation

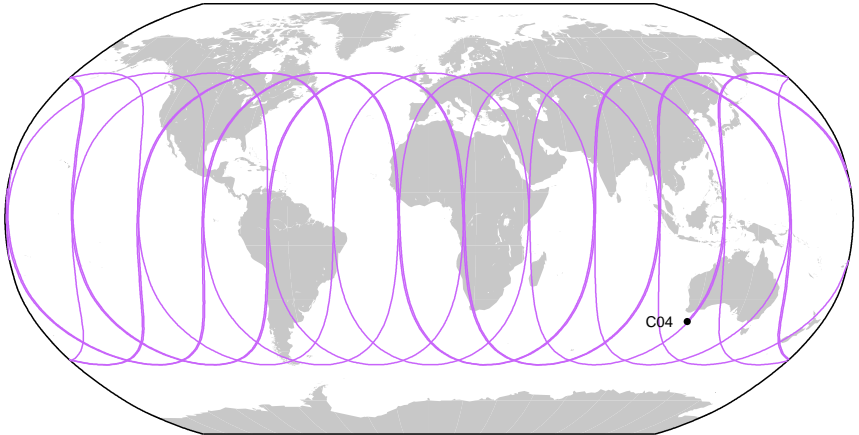

Fictive C04 for 10 days

# BeiDou Constellation

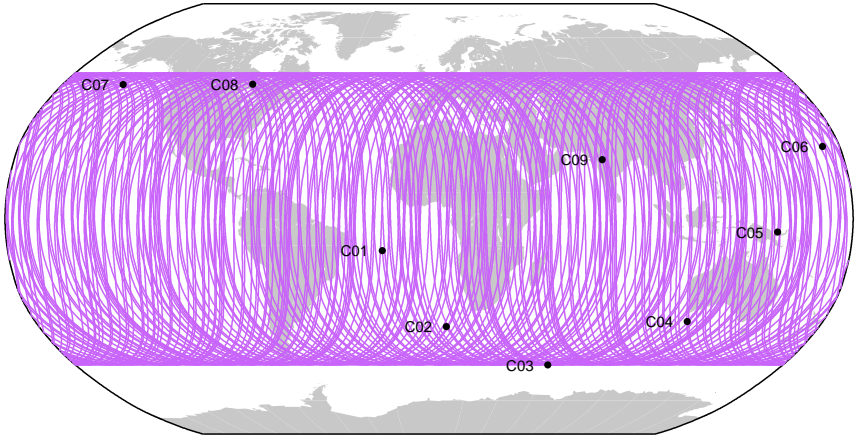

Fictive C01 to C09 for 10 days

# BeiDou Constellation

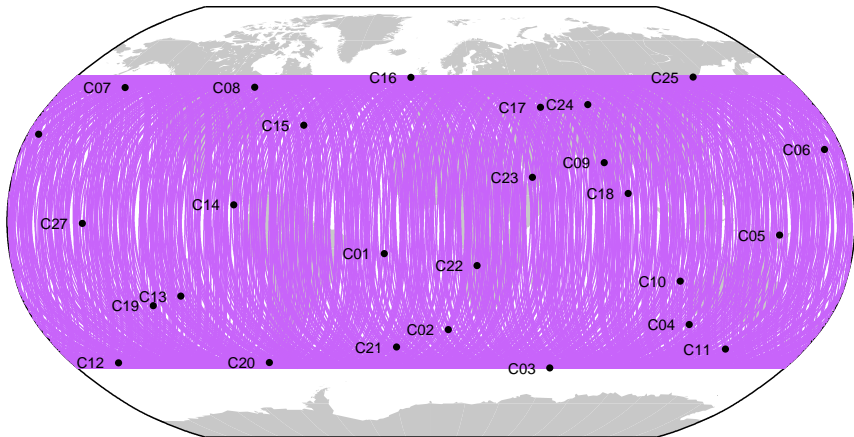

R. Dach: GNSS Satellite Orbit Modelling  
NGK Summer School, 29.Aug.-01. Sep. 2016, Bâstard

Fictive BeiDou constellation for 10 days

# BeiDou Constellation

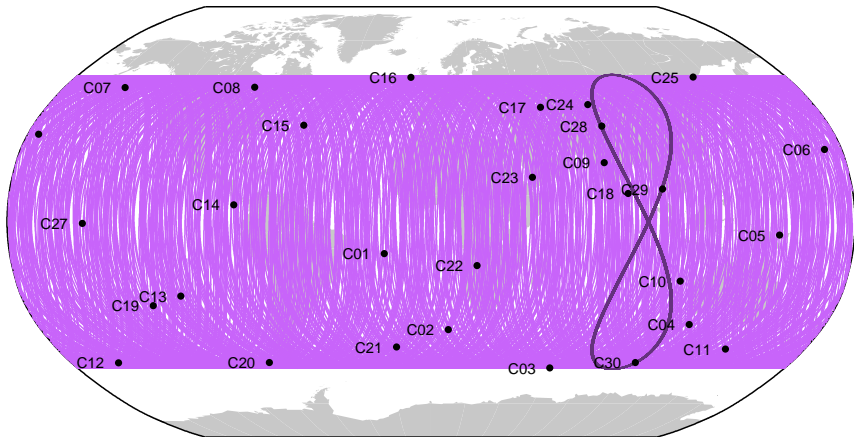

Fictive BeiDou constellation for 10 days



# BeiDou Constellation

---

## Fact sheet (part 2)

### Orbital elements for BeiDou satellites

$a$ : 42 000 km

$e$ : 0 (circular orbit)

$i$ : 55° (IGSO) 0° (GEO)

### Distribution of orbital planes for IGSO–satellites

Number	3	separated by $\Omega_i = \Omega_0 + n \cdot 120^\circ$
Satellites	1	distributed in a way that all satellites follow the same ground track
	= 3 nominal constellation	

# BeiDou Constellation

---

## Fact sheet (part 2)

### Orbital elements for BeiDou satellites

$a$ : 42 000 km

$e$ : 0 (circular orbit)

$i$ : 55° (IGSO) 0° (GEO)

### Distribution of orbital planes for IGSO–satellites

Number 3 separated by  $\Omega_i = \Omega_0 + n \cdot 120^\circ$   
Satellites 1 distributed in a way that all satellites  
follow the same ground track  
= 3 nominal constellation

### Repetition rates

Revolution period 23 h 56 min

Constellation after one revolutions within 1 sidereal day

# QZSS Constellation

---

## Fact sheet

### Orbital elements for QZSS satellites

$a$ : 42 000 km

$e$ : 0.075       $\omega$ : 270°

$i$ : 43°

### Distribution of orbital planes

Number	3	separated by $\Omega_i = \Omega_0 + n \cdot 120^\circ$
Satellites	1	distributed in a way that all satellites follow the same ground track

= 3 nominal constellation

# QZSS Constellation

---

## Fact sheet

### Orbital elements for QZSS satellites

$a$ :	42 000 km		
$e$ :	0.075	$\omega$ :	270°
$i$ :	43°		

### Distribution of orbital planes

Number	3	separated by $\Omega_i = \Omega_0 + n \cdot 120^\circ$
Satellites	1	distributed in a way that all satellites follow the same ground track
		= 3 nominal constellation

### Repetition rates

Revolution period	23 h 56 min
Constellation	after one revolutions within 1 sidereal day

# QZSS Constellation

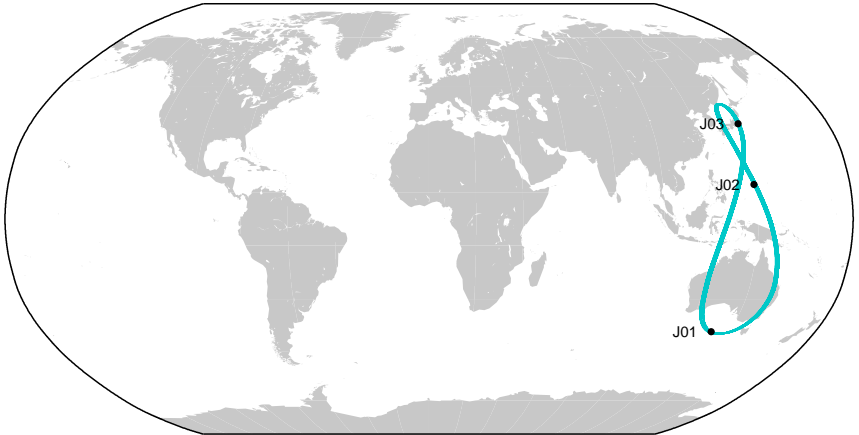

Fictive QZSS constellation for 10 days

# QZSS Constellation

## QZSS Satellites



Approximate dimensions:

bus:  $3 \times 3 \times 6$  m

solar panels:  $2.9 \times 3.1 \times 6.2$  m

width tip-to-tip 25 m

Mass at launch:  $\approx 4$  t

Pictures from JAXA.

# GNSS Constellation Summary

## Global Navigation Systems



GPS



GLONASS



Galileo



BeiDou

## Regional and Augmentation Systems



QZSS



NAVIC

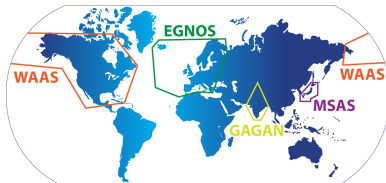

SBAS

# Effects Acting on Satellites and Related Models

---

Introduction and Motivation

Overview on the GNSS Constellations

Effects Acting on Satellites and Related Models

Gravitational Forces

Radiation Pressure Effects

Emmission Effects

Precise Orbit Determination for GNSS Satellites

GNSS Orbit Determination within the IGS



# Gravitational Forces

---



# Gravitational Forces

---



# Gravitational Forces

---

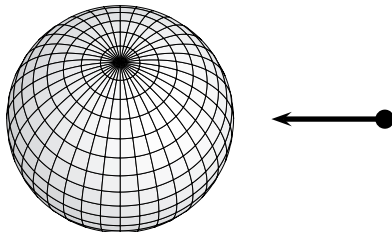

# Gravitational Forces

---

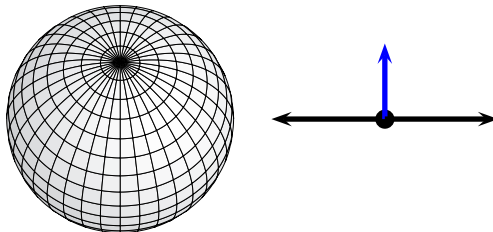

# Gravitational Forces

---

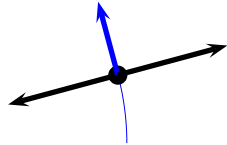
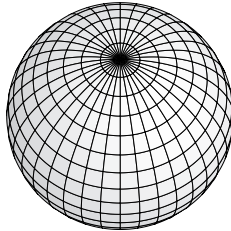

# Gravitational Forces

---

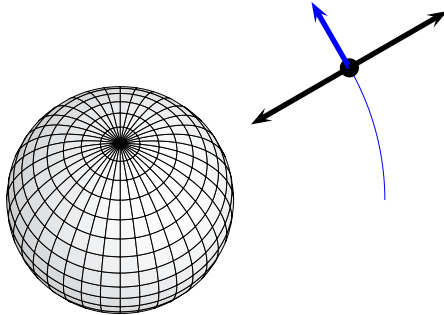

# Gravitational Forces

---

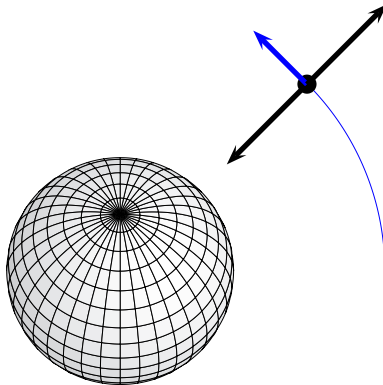

# Gravitational Forces

---

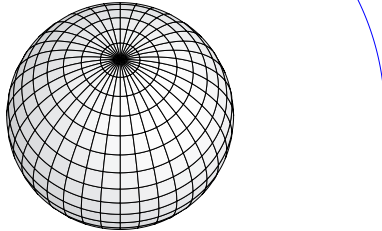



# Gravitational Forces

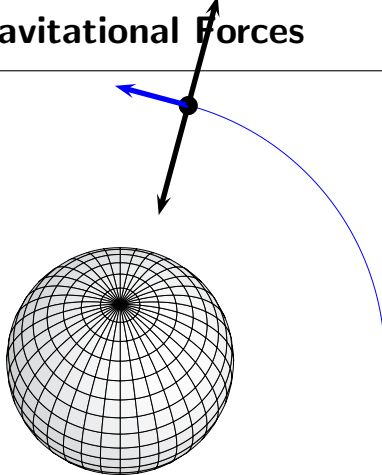

# Gravitational Forces

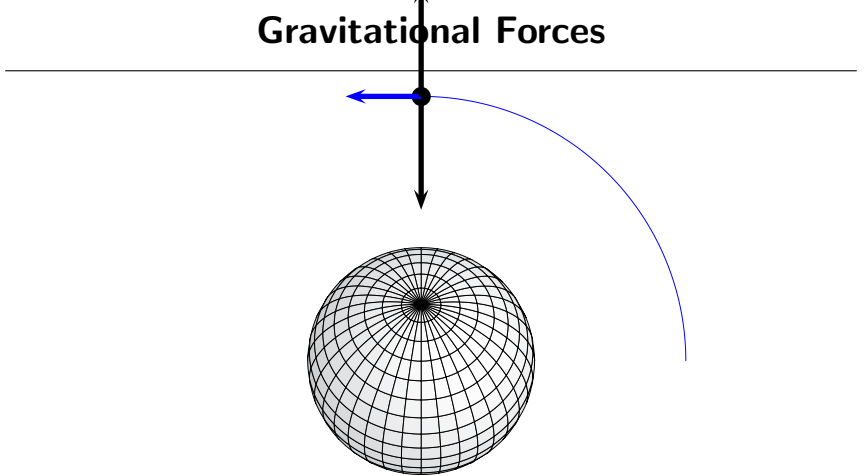

# Gravitational Forces

---

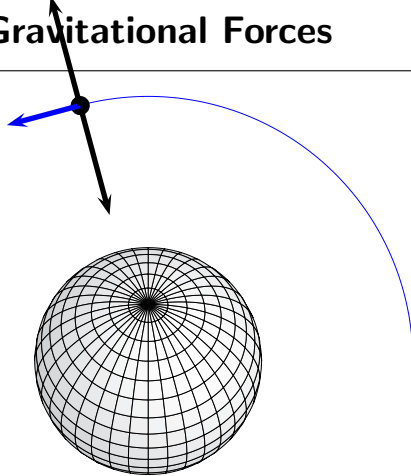

# Gravitational Forces

---

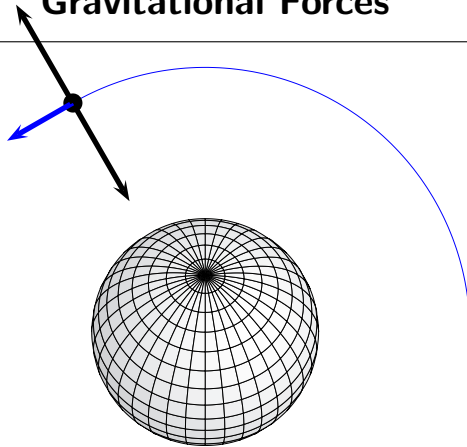

# Gravitational Forces

---

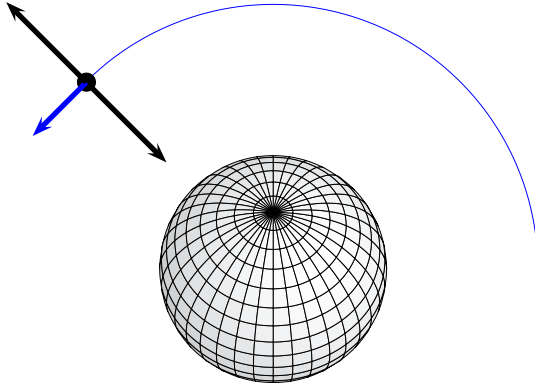

# Gravitational Forces

---

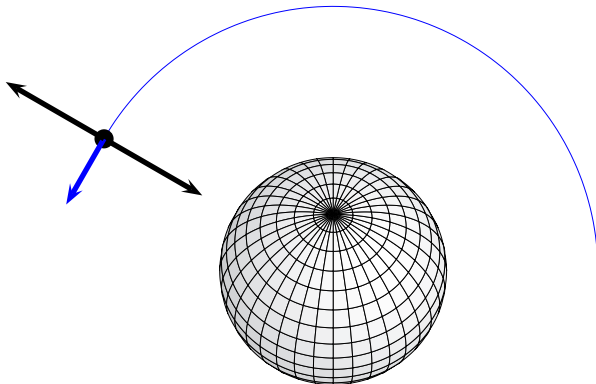

# Gravitational Forces

---

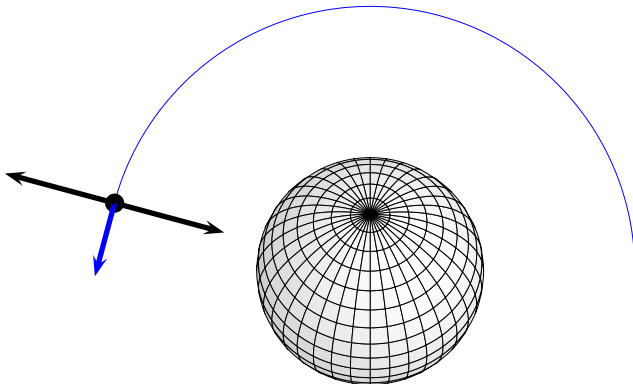

# Gravitational Forces

---

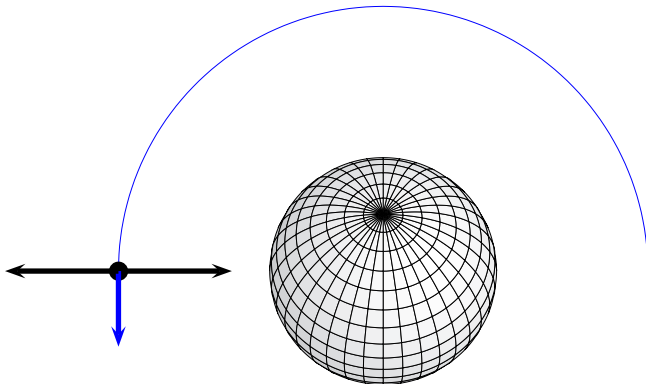



# Gravitational Forces

---

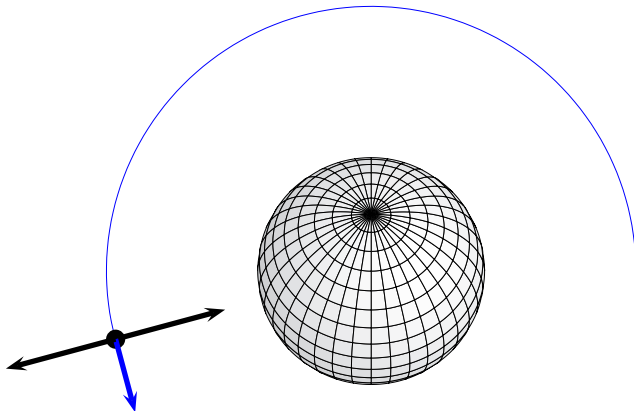

# Gravitational Forces

---

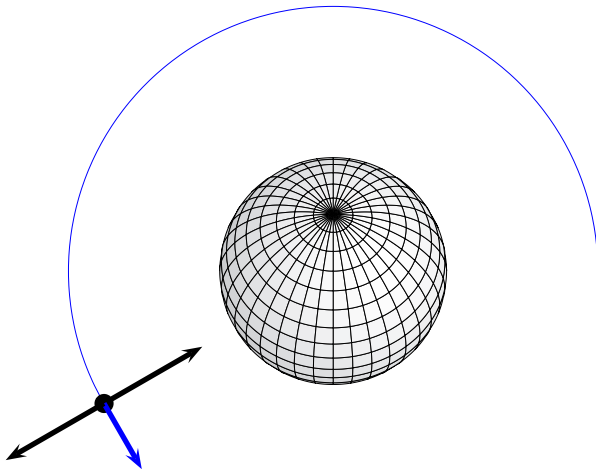

# Gravitational Forces

---

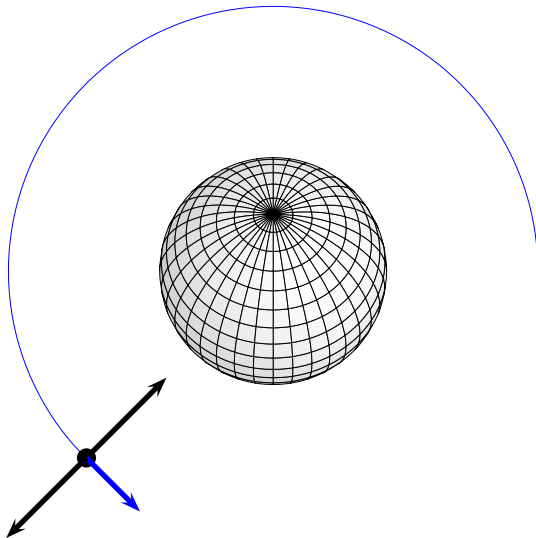

# Gravitational Forces

---

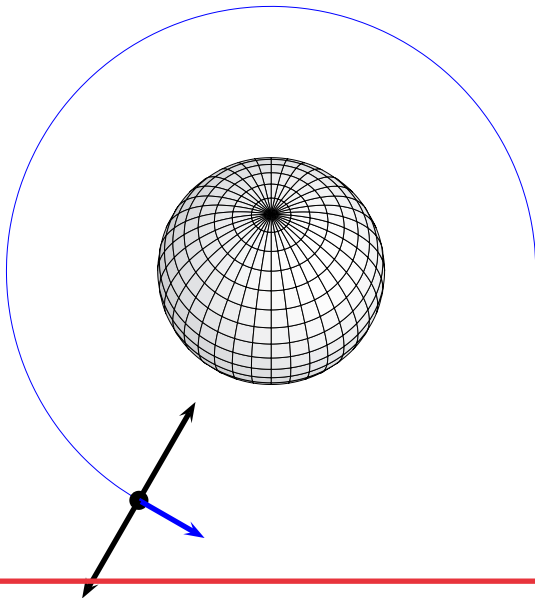

# Gravitational Forces

---

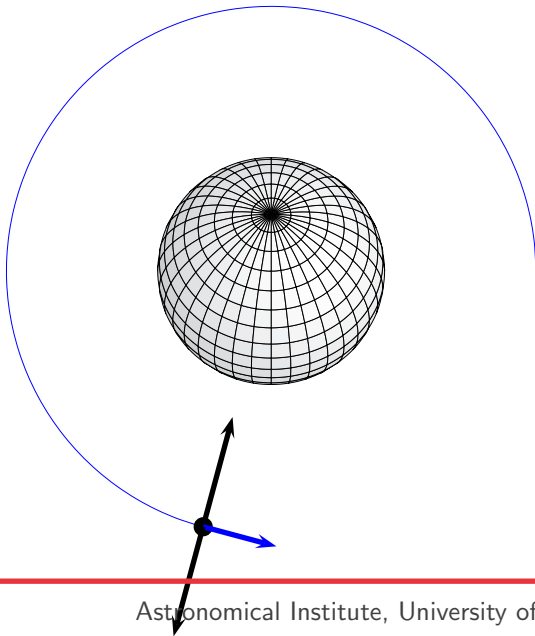

# Gravitational Forces

---

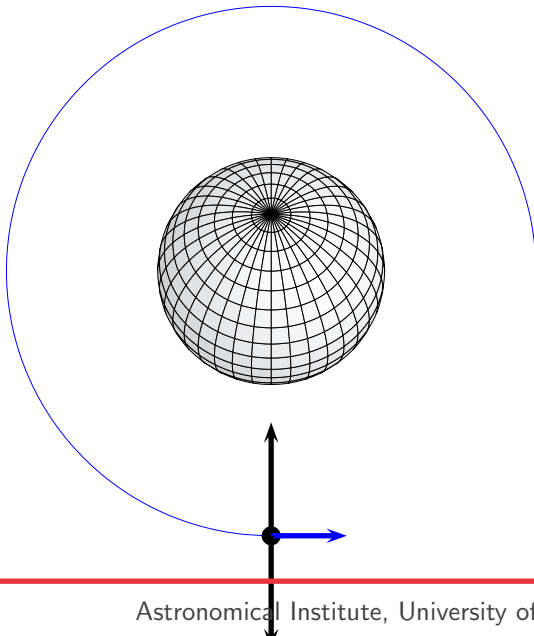

# Gravitational Forces

---

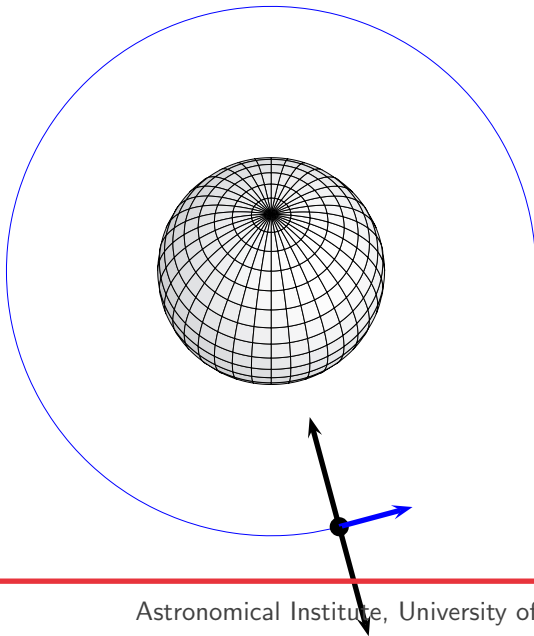

# Gravitational Forces

---

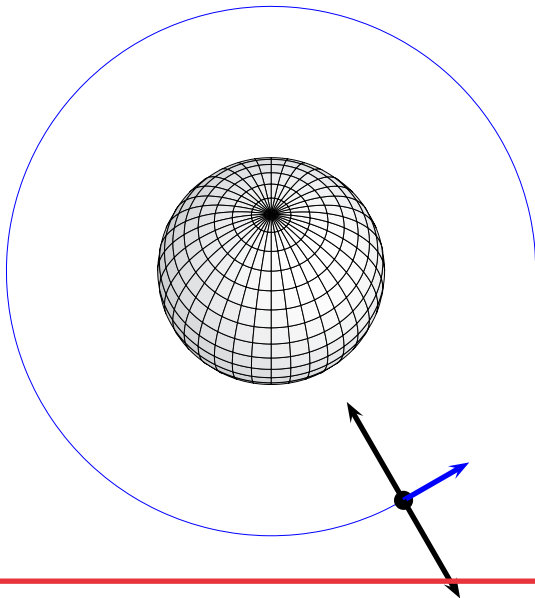



# Gravitational Forces

---

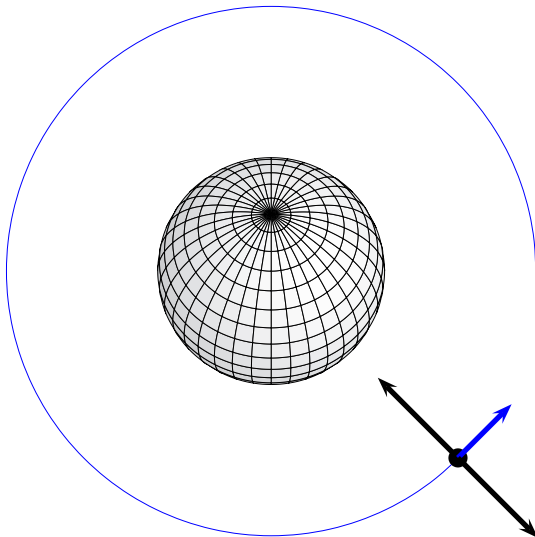

# Gravitational Forces

---

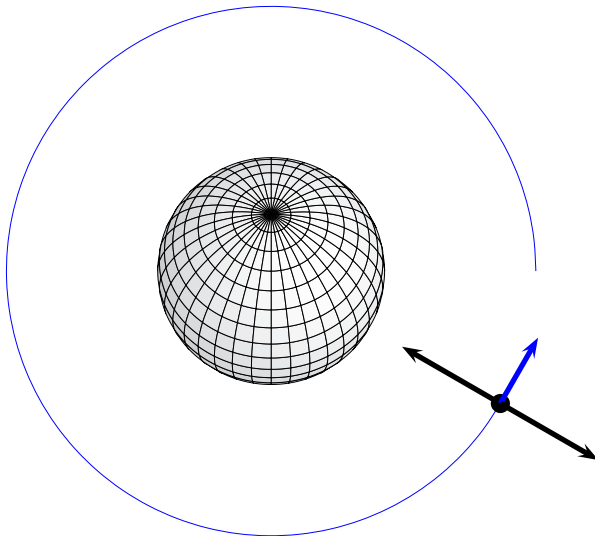

# Gravitational Forces

---

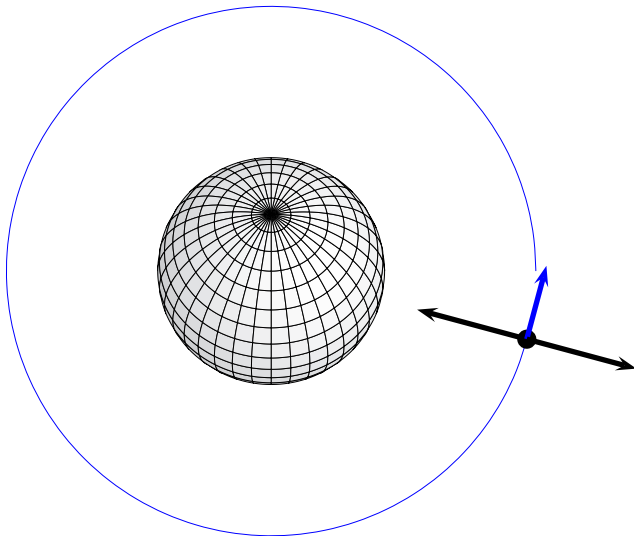

# Gravitational Forces

---

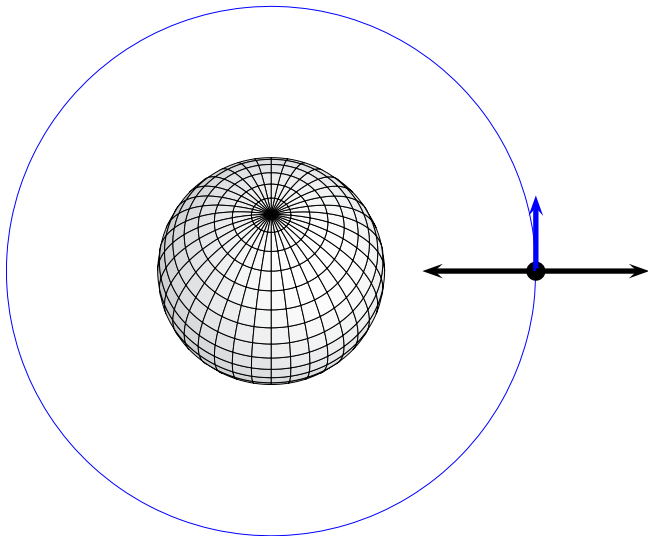

# Gravitational Forces

---

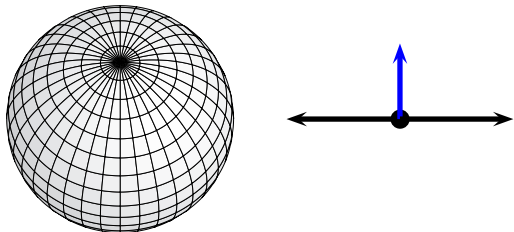

# Gravitational Forces

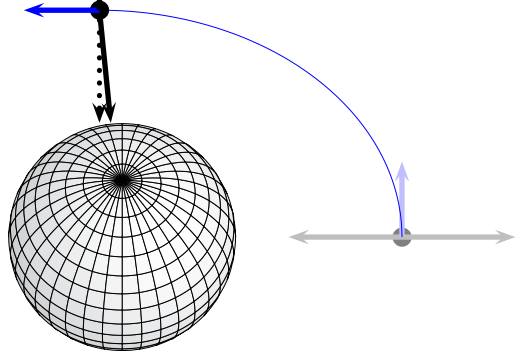

# Gravitational Forces

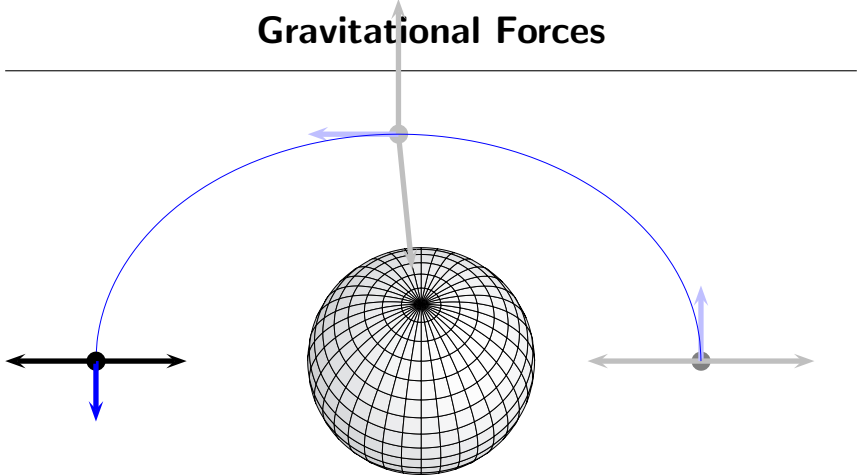

# Gravitational Forces

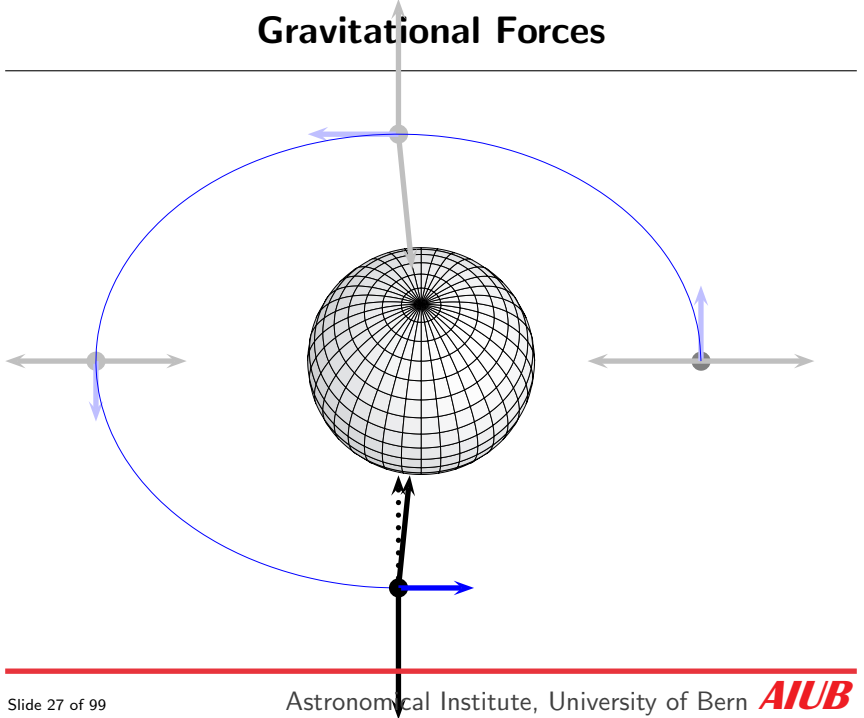



# Gravitational Forces

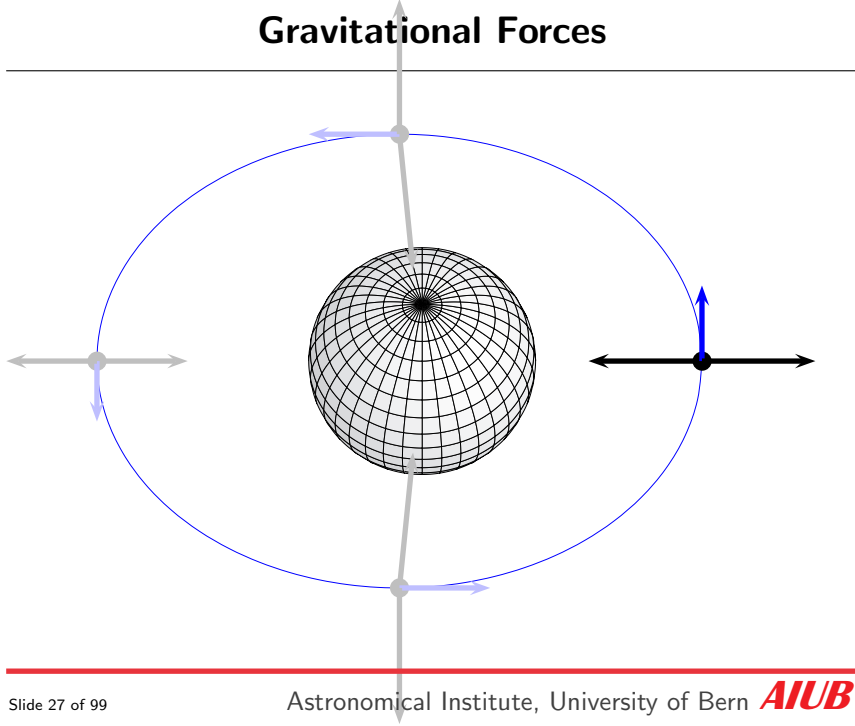

# Gravitational Forces

---

Acceleration due to centrifugal force:

$$\ddot{\vec{r}} = \frac{|\dot{\vec{r}}|^2}{|\vec{r}|} \cdot \frac{\vec{r}}{|\vec{r}|} \quad (1)$$

Acceleration due to gravitational force:

$$\ddot{\vec{r}} = -GM_E \cdot \frac{\vec{r}}{|\vec{r}|^3} \quad (2)$$

- $GM_E$  product of the constant of gravity and the mass of the Earth
- $\vec{r}$  geocentric vector to the satellite
- $\dot{\vec{r}}$  the related first time derivative (velocity vector)
- $\ddot{\vec{r}}$  the related second time derivative (acceleration vector)

# Gravitational Forces

## Velocities of selected GNSS satellites:

- Starting with the radius of the satellite orbit, the gravitational acceleration can be computed according to equation (2), with  $GM_E = 398.6004415 \cdot 10^{12} \frac{\text{m}^3}{\text{s}^2}$ .
- To compensate the gravitational acceleration a velocity of the satellite according to equation (1) is needed.

Satellite	$ \vec{r} $ in km	$ \ddot{\vec{r}} $ in $\frac{\text{m}}{\text{s}^2}$	$ \dot{\vec{r}} $ in $\frac{\text{km}}{\text{s}}$
GLONASS	25 500	0.613	3.95
GPS	26 560	0.565	3.87
Galileo	30 000	0.443	3.65
BeiDou, IGSO	42 000	0.226	3.08

# Keplerian Orbit

---

## The Equation of Motion:

$$\ddot{\vec{r}} = -GM_E \frac{\vec{r}}{|\vec{r}|^3} \quad (3)$$

- describes the motion of a satellite around a spherically symmetric Earth.

# Keplerian Orbit

---

## The Equation of Motion:

$$\ddot{\vec{r}} = -GM_E \frac{\vec{r}}{|\vec{r}|^3} \quad (3)$$

- describes the motion of a satellite around a spherically symmetric Earth.
- is a differential equation with a solution describing either an ellipse, a parabola, or a hyperbola.

# Keplerian Orbit

---

## The Equation of Motion:

$$\ddot{\vec{r}} = -GM_E \frac{\vec{r}}{|\vec{r}|^3} \quad (3)$$

- describes the motion of a satellite around a spherically symmetric Earth.
- is a differential equation with a solution describing either an **ellipse**, a parabola, or a hyperbola.

# Keplerian Orbit

---

## The Equation of Motion:

$$\ddot{\vec{r}} = -GM_E \frac{\vec{r}}{|\vec{r}|^3} \quad (3)$$

- describes the motion of a satellite around a spherically symmetric Earth.
- is a differential equation with a solution describing either an **ellipse**, a parabola, or a hyperbola.

It describes the trajectory of the satellite along a so called **Keplerian orbit ellipse**.

# Quasi-Inertial Coordinate System

---

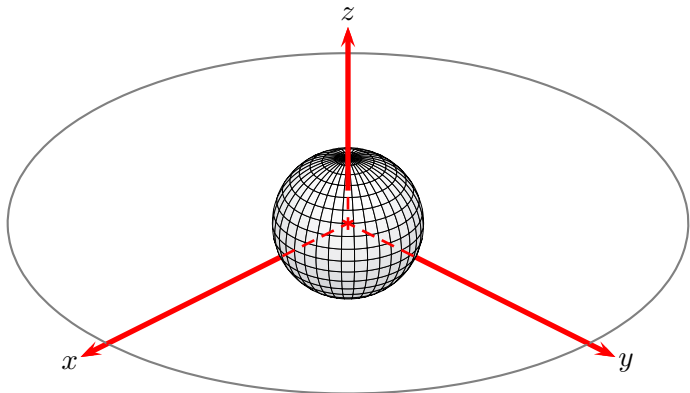

- Origin is located in the center of mass of the Earth.



# Quasi-Inertial Coordinate System

---

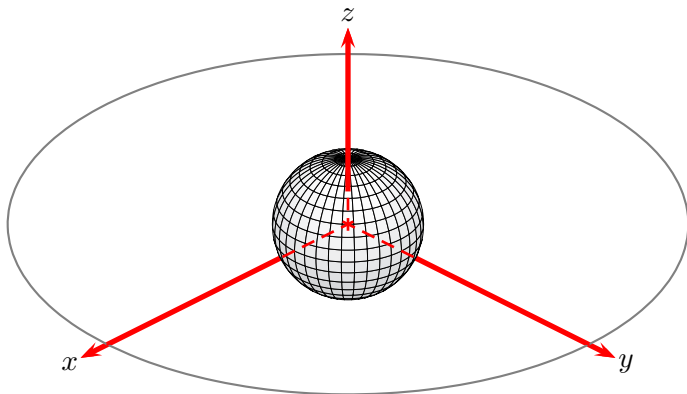

- Z-axis corresponds to the mean rotation axis of the Earth.
- X-axis points to the vernal equinox (intersection with the ecliptic).

# Quasi-Inertial Coordinate System

---

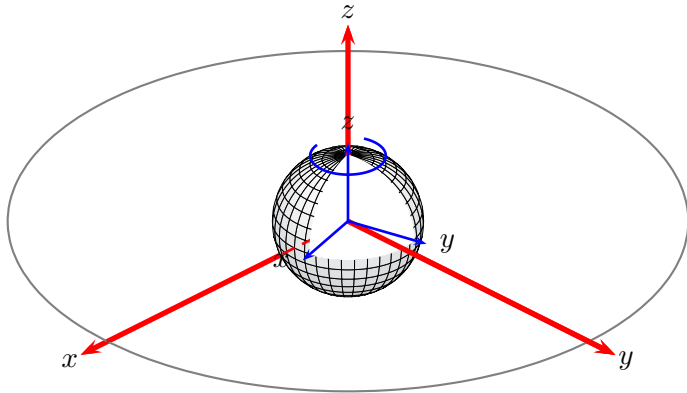

- The coordinate system does not follow the rotation of the Earth but follows the motion of the Earth around the Sun.

# Quasi-Inertial Coordinate System

---

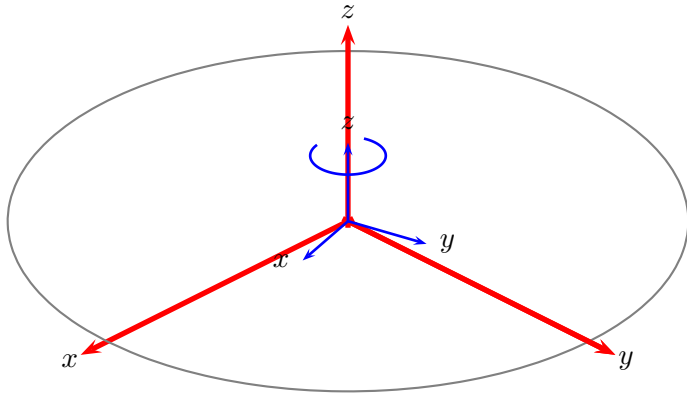

- The coordinate system does not follow the rotation of the Earth but follows the motion of the Earth around the Sun.

# Keplerian Orbit Ellipse

---

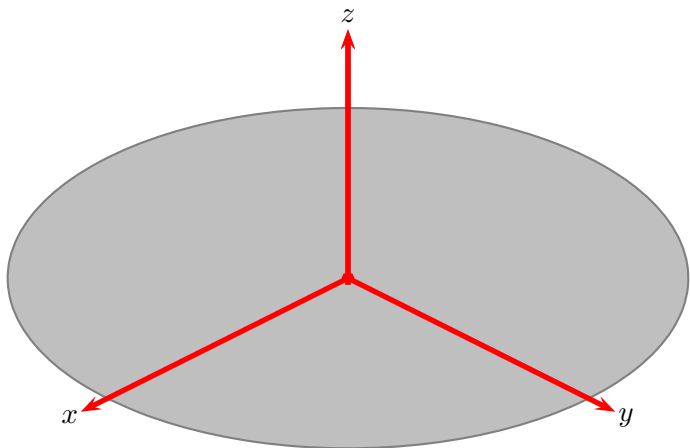

# Keplerian Orbit Ellipse

---

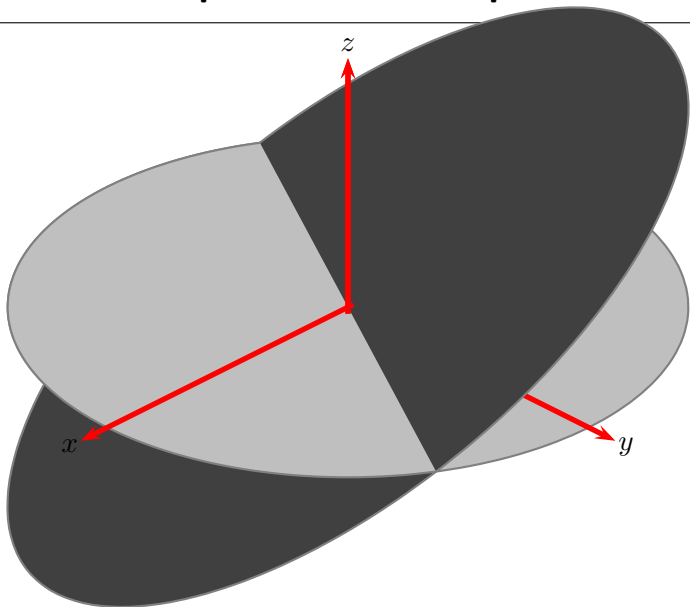

# Keplerian Orbit Ellipse

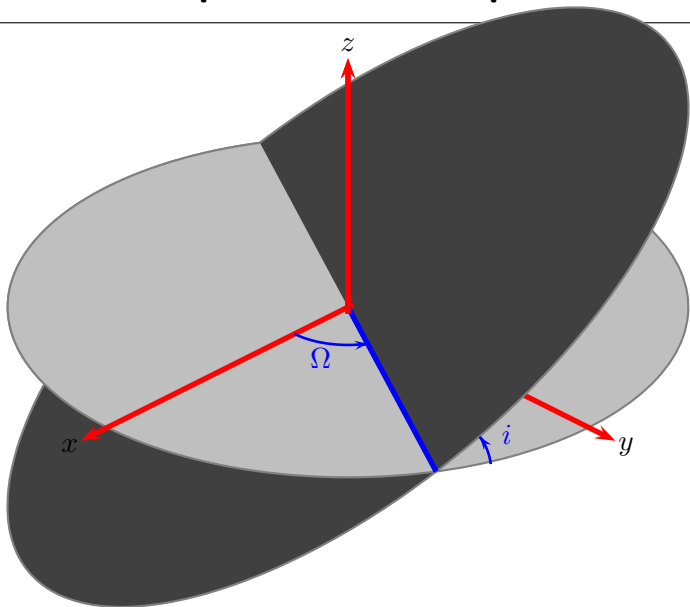

# Keplerian Orbit Ellipse

Perigee

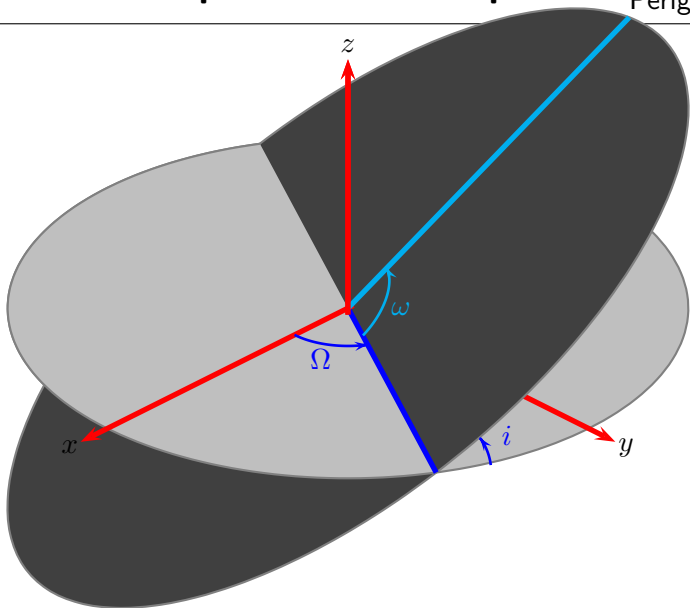

# Keplerian Orbit Ellipse

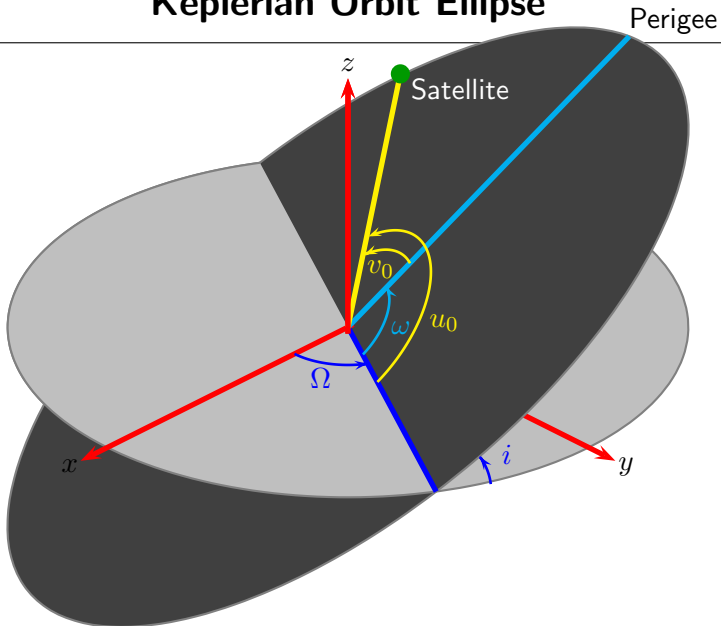



# Keplerian Orbit Ellipse

---

## Description of the orbit ellipse

- $a$  semimajor axis
- $e$  numerical eccentricity

## Location of the orbit ellipse

- $i$  inclination of the orbital plane
- $\Omega$  right ascension of the ascending node
- $\omega$  argument of perigee

## Location of the satellite within the orbit ellipse

- $u_0(t_0)$  argument of latitude of the satellite at  $t_0$
- $v_0(t_0)$  true anomaly at epoch  $t_0$   
with  $u_0(t_0) = \omega + v_0(t_0)$

# Advancing the Keplerian Orbit Theory

---

Gravitational effect of other celestial bodies:

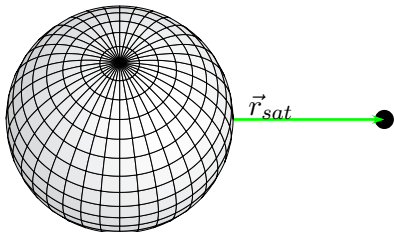

# Advancing the Keplerian Orbit Theory

Gravitational effect of other celestial bodies:

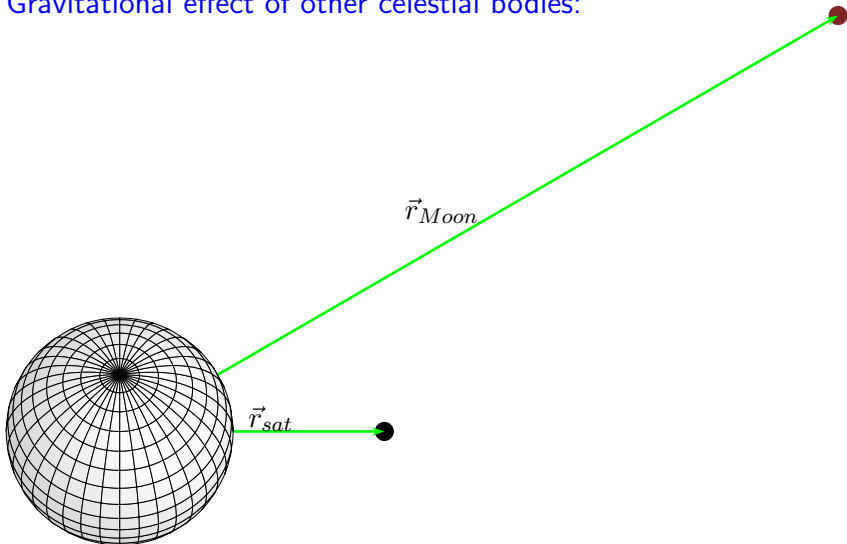

# Advancing the Keplerian Orbit Theory

Gravitational effect of other celestial bodies:

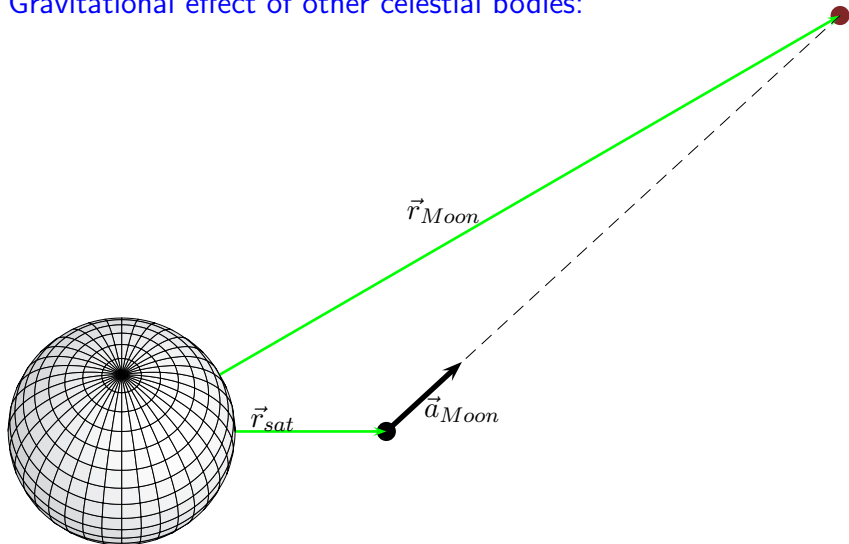

# Advancing the Keplerian Orbit Theory

Gravitational effect of other celestial bodies:

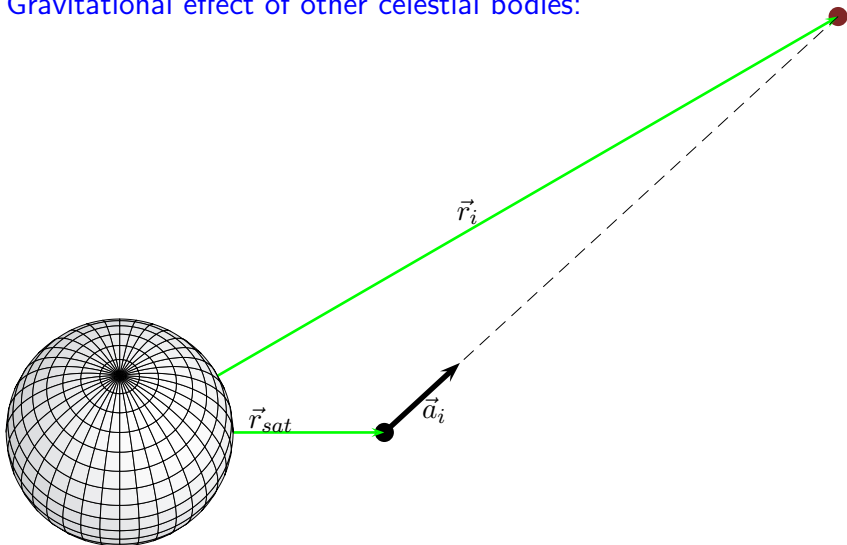

# Advancing the Keplerian Orbit Theory

---

Gravitational effect of other celestial bodies:

$$\ddot{\vec{r}}_{sat} = -GM_E \frac{\vec{r}_{sat}}{|\vec{r}_{sat}|^3} - G \cdot \sum_{i=1}^n M_i \frac{\vec{r}_i - \vec{r}_{sat}}{|\vec{r}_i - \vec{r}_{sat}|^3}$$

# Advancing the Keplerian Orbit Theory

---

Gravitational effect of other celestial bodies:

$$\ddot{\vec{r}}_{sat} = \underbrace{-GM_E \frac{\vec{r}_{sat}}{|\vec{r}_{sat}|^3}}_{\text{Keplerian motion}} - \underbrace{G \cdot \sum_{i=1}^n M_i \frac{\vec{r}_i - \vec{r}_{sat}}{|\vec{r}_i - \vec{r}_{sat}|^3}}_{\text{relevant celestial bodies}}$$

- Further gravitational effects act on the satellite as well.

The resulting satellite motion is described by a **perturbed Keplerian motion**.

# Advancing the Keplerian Orbit Theory

---

Gravitational effect of other celestial bodies:

$$\ddot{\vec{r}}_{sat} = \underbrace{-GM_E \frac{\vec{r}_{sat}}{|\vec{r}_{sat}|^3}}_{\text{Keplerian motion}} - \underbrace{G \cdot \sum_{i=1}^n M_i \frac{\vec{r}_i - \vec{r}_{sat}}{|\vec{r}_i - \vec{r}_{sat}|^3}}_{\text{relevant celestial bodies}}$$

- Further gravitational effects act on the satellite as well.

The resulting satellite motion is described by a **perturbed Keplerian motion**.

- The elements of the orbit ellipse change continuously due to the perturbing forces – “osculating elements”.



# The Earth is not Spherically Symmetric

---

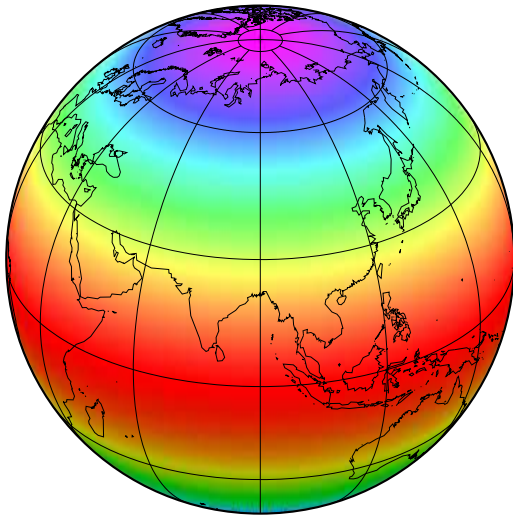

The dominate structure is oblateness of the Earth

# The Earth is not Spherically Symmetric

---

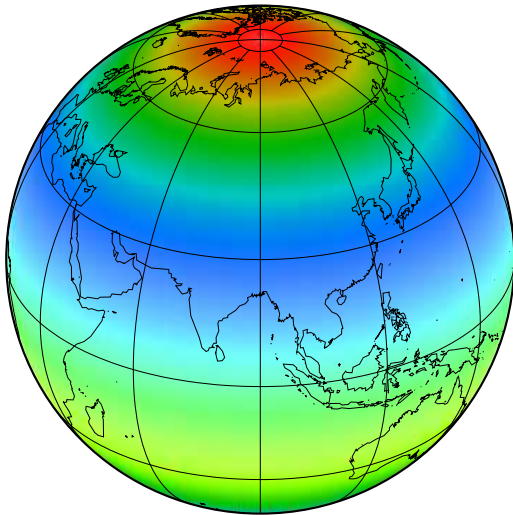

In the next order it has a shape of a pear

# The Earth is not Spherically Symmetric

---

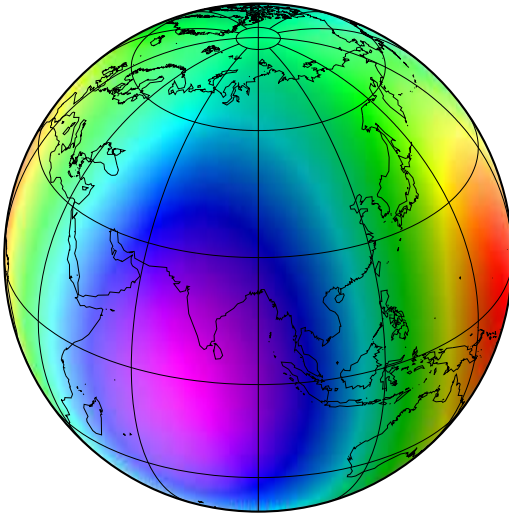

There are also relevant longitude-dependent structures

# The Earth is not Spherically Symmetric

---

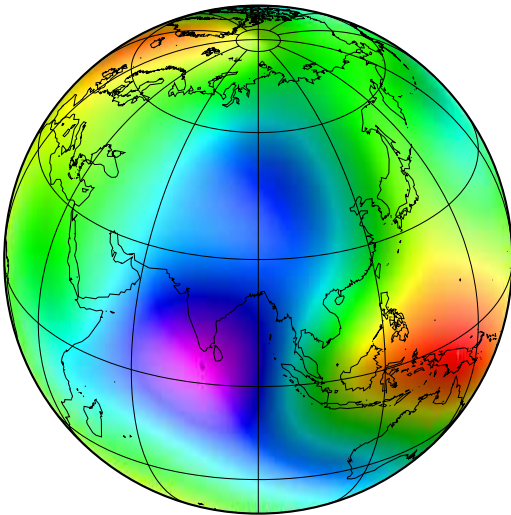

Many more details of the gravity field are well known today. . .

# The Earth is not Spherically Symmetric

---

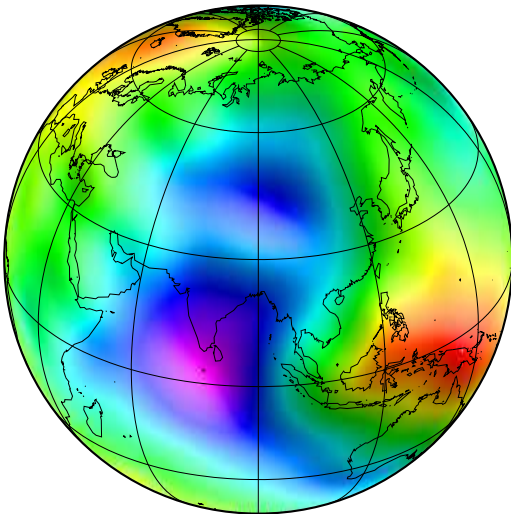

Many more details of the gravity field are well known today. . .

# The Earth is not Spherically Symmetric

---

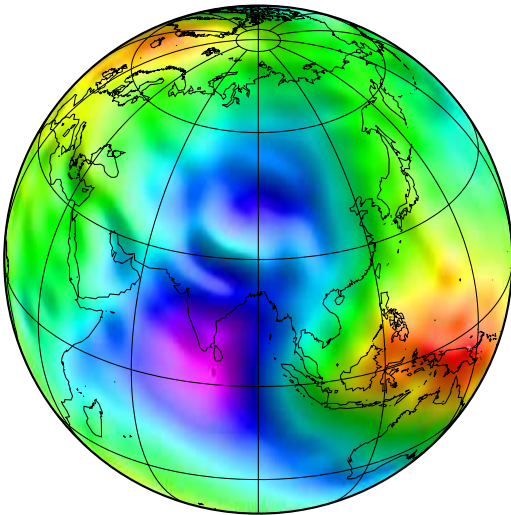

Many more details of the gravity field are well known today. . .

# The Earth is not Spherically Symmetric

---

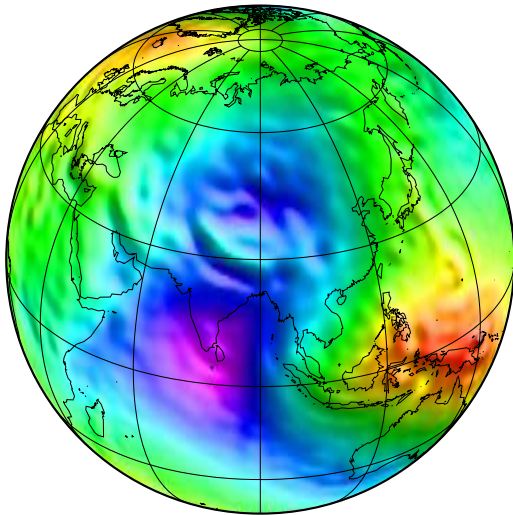

Many more details of the gravity field are well known today. . .

# The Earth is not Spherically Symmetric

---

Considering the gravity field for GNSS orbit determination

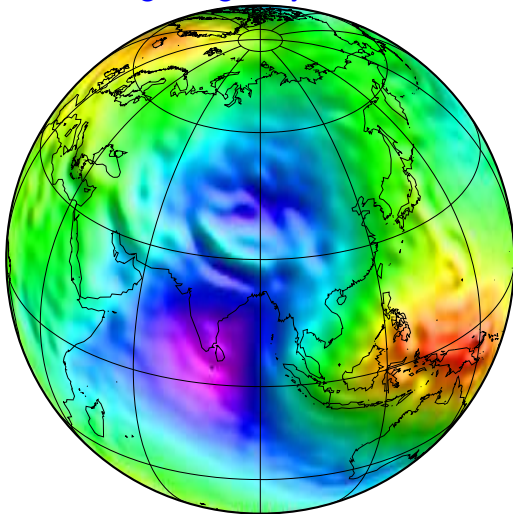

Many more details of the gravity field are well known today. . .



# The Earth is not Spherically Symmetric

---

Considering the mass distribution of the Earth:

$$\ddot{\vec{r}}_{sat} = -GM_E \int_{V_E} \rho'(\vec{r}_P) \frac{\vec{r}_{sat} - \vec{r}_P}{|\vec{r}_{sat} - \vec{r}_P|^3} dV_E - G \cdot \sum_{i=1}^n M_i \frac{\vec{r}_i - \vec{r}_{sat}}{|\vec{r}_i - \vec{r}_{sat}|^3}$$

# The Earth is not Spherically Symmetric

---

Considering the mass distribution of the Earth:

$$\ddot{\vec{r}}_{sat} = -GM_E \int_{V_E} \varrho'(\vec{r}_P) \frac{\vec{r}_{sat} - \vec{r}_P}{|\vec{r}_{sat} - \vec{r}_P|^3} dV_E - G \cdot \sum_{i=1}^n M_i \frac{\vec{r}_i - \vec{r}_{sat}}{|\vec{r}_i - \vec{r}_{sat}|^3}$$

- The first term represents the gravitational attraction by the Earth, where  $\varrho'(\vec{r}_P)$  is the density at  $\vec{r}_P$  in the Earth's interior.

# The Earth is not Spherically Symmetric

Considering the mass distribution of the Earth:

$$\ddot{\vec{r}}_{sat} = -GM_E \int_{V_E} \varrho'(\vec{r}_P) \frac{\vec{r}_{sat} - \vec{r}_P}{|\vec{r}_{sat} - \vec{r}_P|^3} dV_E - G \cdot \sum_{i=1}^n M_i \frac{\vec{r}_i - \vec{r}_{sat}}{|\vec{r}_i - \vec{r}_{sat}|^3}$$

- The first term represents the gravitational attraction by the Earth, where  $\varrho'(\vec{r}_P)$  is the density at  $\vec{r}_P$  in the Earth's interior.
- The density function of the Earth is given in an **Earth-fixed system**.

$$-GM_E \int_{V_E} \varrho'(\vec{r}_P) \dots dV_E \implies -GM_E \mathbf{T} \int_{V_E} \varrho(\vec{r}_P) \dots dV_E$$

where  $\mathbf{T}$  is the transformation matrix from the Earth-fixed into the quasi-inertial frame.

# The Earth is not Spherically Symmetric

---

Considering the mass distribution of the Earth:

- The related gravity field of the Earth is considered as a conservative vector field

$$GM_E \nabla V(\vec{r}) = GM_E \left( \nabla \int_{V_E} \frac{\rho(\vec{r}_P)}{|\vec{r}_{sat} - \vec{r}_P|} dV_E \right)$$

# The Earth is not Spherically Symmetric

---

Considering the mass distribution of the Earth:

- The related gravity field of the Earth is considered as a conservative vector field that gradients may be represented by a **spherical harmonic expansion of the potential**:

$$\begin{aligned} GM_E \nabla V(\vec{r}) &= GM_E \left( \nabla \int_{V_E} \frac{\rho(\vec{r}_P)}{|\vec{r}_{sat} - \vec{r}_P|} dV_E \right) \\ &= \frac{GM}{|\vec{r}_{sat}|} \sum_{i=0}^{\infty} \left( \frac{a_e}{|\vec{r}_{sat}|} \right)^i \cdot \sum_{k=0}^i P_i^k(\sin \phi) \{C_{ik} \cos k\lambda + S_{ik} \sin k\lambda\} \end{aligned}$$

with

$\phi, \lambda$

$P_i^k(\sin \phi)$

$C_{ik}, S_{ik}$

the spherical latitude and longitude of the satellite,

the associated Legendre functions of degree  $i$  and order  $k$ ,

the coefficients of the expansion of the potential into spherical harmonic functions.

# The Earth is not Spherically Symmetric

Considering the mass distribution of the Earth:

- The related gravity field of the Earth is considered as a conservative vector field that gradients may be represented by a **spherical harmonic expansion of the potential**:

$$\begin{aligned} GM_E \nabla V(\vec{r}) &= GM_E \left( \nabla \int_{V_E} \frac{\rho(\vec{r}_P)}{|\vec{r}_{sat} - \vec{r}_P|} dV_E \right) \\ &= \frac{GM}{|\vec{r}_{sat}|} \sum_{i=0}^{\infty} \left( \frac{a_e}{|\vec{r}_{sat}|} \right)^i \cdot \sum_{k=0}^i P_i^k(\sin \phi) \{ C_{ik} \cos k\lambda + S_{ik} \sin k\lambda \} \end{aligned}$$

with

$\phi, \lambda$

$P_i^k(\sin \phi)$

$C_{ik}, S_{ik}$

the **spherical latitude and longitude of the satellite**,

the associated Legendre functions of degree  $i$  and order  $k$ ,

the coefficients of the expansion of the potential into spherical harmonic functions.

# The Earth is not Spherically Symmetric

Considering the mass distribution of the Earth:

- The related gravity field of the Earth is considered as a conservative vector field that gradients may be represented by a **spherical harmonic expansion of the potential**:

$$\begin{aligned} GM_E \nabla V(\vec{r}) &= GM_E \left( \nabla \int_{V_E} \frac{\rho(\vec{r}_P)}{|\vec{r}_{sat} - \vec{r}_P|} dV_E \right) \\ &= \frac{GM}{|\vec{r}_{sat}|} \sum_{i=0}^{\infty} \left( \frac{a_e}{|\vec{r}_{sat}|} \right)^i \cdot \sum_{k=0}^i P_i^k(\sin \phi) \{C_{ik} \cos k\lambda + S_{ik} \sin k\lambda\} \end{aligned}$$

with

$\phi, \lambda$

$P_i^k(\sin \phi)$

$C_{ik}, S_{ik}$

the spherical latitude and longitude of the satellite,

the **associated Legendre functions of degree  $i$  and order  $k$** ,

the coefficients of the expansion of the potential into spherical harmonic functions.

# The Earth is not Spherically Symmetric

---

Considering the mass distribution of the Earth:

- The related gravity field of the Earth is considered as a conservative vector field that gradients may be represented by a spherical harmonic expansion of the potential:

$$\begin{aligned} GM_E \nabla V(\vec{r}) &= GM_E \left( \nabla \int_{V_E} \frac{\rho(\vec{r}_P)}{|\vec{r}_{sat} - \vec{r}_P|} dV_E \right) \\ &= \frac{GM}{|\vec{r}_{sat}|} \sum_{i=0}^{\infty} \left( \frac{a_e}{|\vec{r}_{sat}|} \right)^i \cdot \sum_{k=0}^i P_i^k(\sin \phi) \{ C_{ik} \cos k\lambda + S_{ik} \sin k\lambda \} \end{aligned}$$

with

$\phi, \lambda$

$P_i^k(\sin \phi)$

$C_{ik}, S_{ik}$

the spherical latitude and longitude of the satellite,  
the associated Legendre functions of degree  $i$  and order  $k$ ,  
the coefficients of the expansion of the potential into  
spherical harmonic functions.



# The Earth is not Spherically Symmetric

Considering the mass distribution of the Earth:

$$k = 0 \quad l = 0$$



$$k = 1 \quad l = 0, 1$$

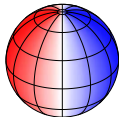
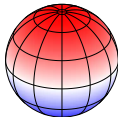

$$k = 2 \quad l = 0, \dots, 2$$

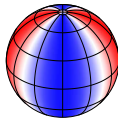

$$k = 3 \quad l = 0, \dots, 3$$

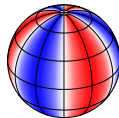
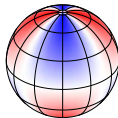
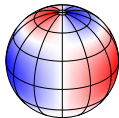
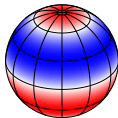

# The Earth is not Spherically Symmetric

Considering the mass distribution of the Earth:

$$k = 0 \quad l = 0$$

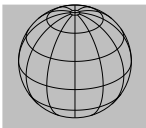

The first term  $C_{00}$  is a constant.

$$k = 1 \quad l = 0, 1$$

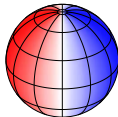
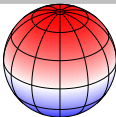

$$k = 2 \quad l = 0, \dots, 2$$

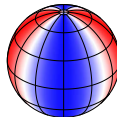

$$k = 3 \quad l = 0, \dots, 3$$

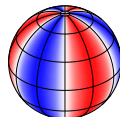
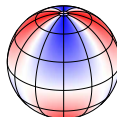
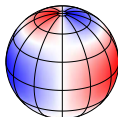
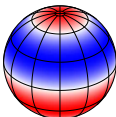

# The Earth is not Spherically Symmetric

Considering the mass distribution of the Earth:

$$k = 0 \quad l = 0$$



The terms  $C_{10}$ ,  $C_{11}$ , and  $S_{11}$  are related to the center of mass of the Earth.

$$k = 1 \quad l = 0, 1$$

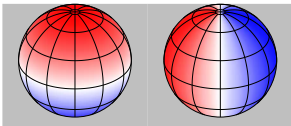

$$k = 2 \quad l = 0, \dots, 2$$



$$k = 3 \quad l = 0, \dots, 3$$

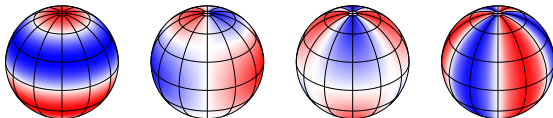

# The Earth is not Spherically Symmetric

Considering the mass distribution of the Earth:

$$k = 0 \quad l = 0$$



The  $C_{20}$  term represents the **flattening** of the Earth.

$$k = 1 \quad l = 0, 1$$

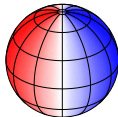
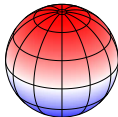

$$k = 2 \quad l = 0, \dots, 2$$

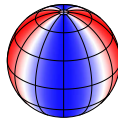
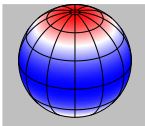

$$k = 3 \quad l = 0, \dots, 3$$

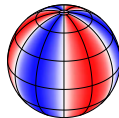
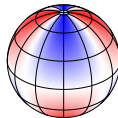
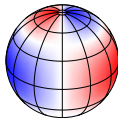
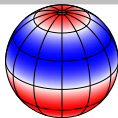

# The Earth is not Spherically Symmetric

Considering the mass distribution of the Earth:

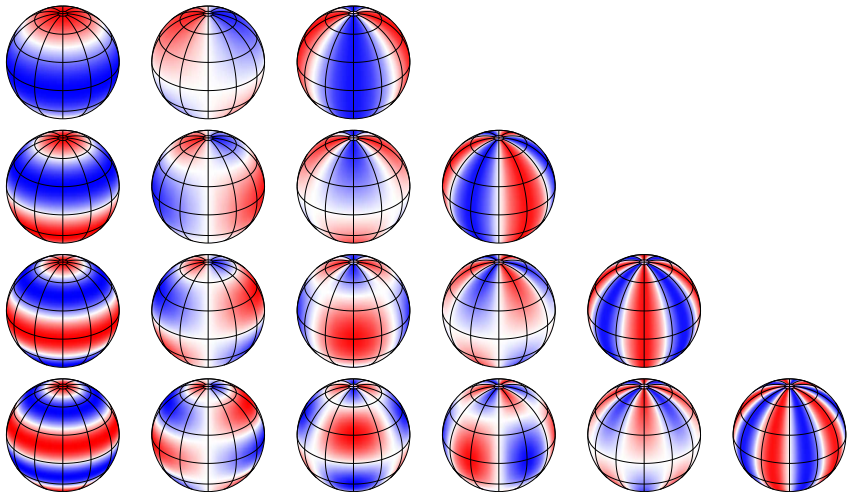

# The Earth is not Spherically Symmetric

Considering the mass distribution of the Earth:

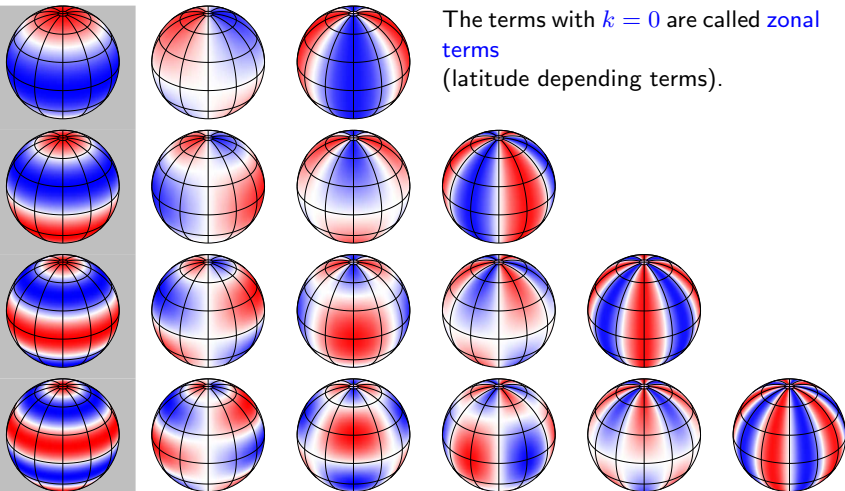

# The Earth is not Spherically Symmetric

Considering the mass distribution of the Earth:

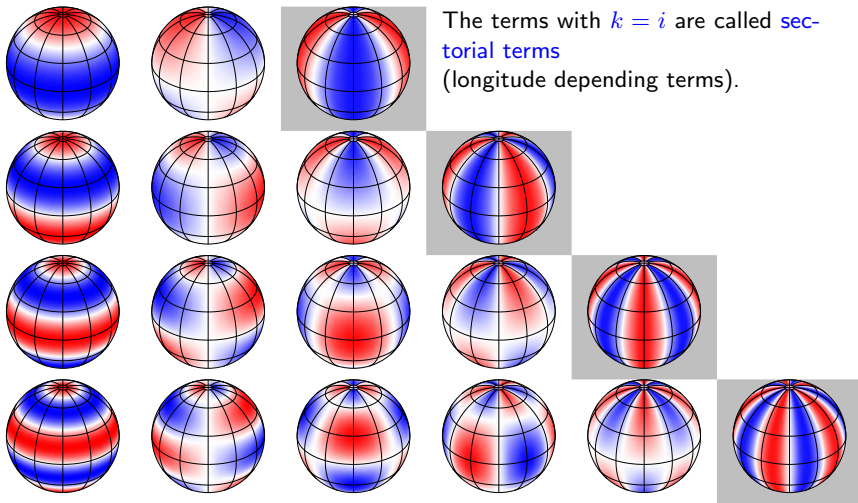

# The Earth is not Spherically Symmetric

Considering the mass distribution of the Earth:

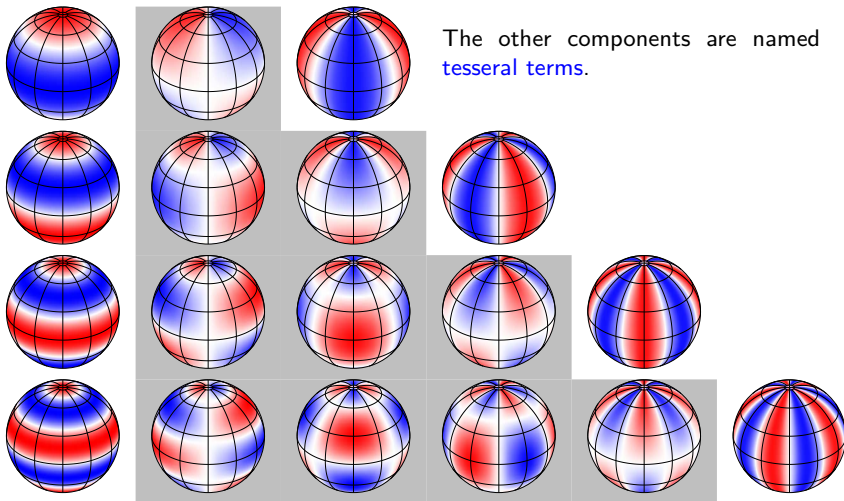



# The Earth is not Spherically Symmetric

---

To which extent the gravity field is relevant for orbit determination of GNSS satellites?

# The Earth is not Spherically Symmetric

To which extent the gravity field is relevant for orbit determination of GNSS satellites?

GNSS	$i, k \leq 2$	$i, k \leq 3$	$i, k \leq 4$	$i, k \leq 5$	$i, k \leq 6$
GLONASS	$\approx 5$ m	$\approx 0.5$ m	$\approx 8$ cm	$\approx 1.5$ cm	$\approx 5$ mm
GPS	$\approx 5$ m	$\approx 0.5$ m	$\approx 8$ cm	$\approx 1.5$ cm	$< 5$ mm
Galileo	$\approx 2$ m	$\approx 0.2$ m	$\approx 3$ cm	$\approx 5$ mm	$\approx 1$ mm
IGSO/GEO	$< 1$ m	$\approx 5$ cm	$< 5$ mm	$\approx 1$ mm	—

3D-RMS of the orbit differences w.r.t. an orbit based on a gravity field expanded up to degree and order 20.

# The Earth is not Spherically Symmetric

To which extent the gravity field is relevant for orbit determination of GNSS satellites?

GNSS	$i, k \leq 2$	$i, k \leq 3$	$i, k \leq 4$	$i, k \leq 5$	$i, k \leq 6$
GLONASS	$\approx 5$ m	$\approx 0.5$ m	$\approx 8$ cm	$\approx 1.5$ cm	$\approx 5$ mm
GPS	$\approx 5$ m	$\approx 0.5$ m	$\approx 8$ cm	$\approx 1.5$ cm	$< 5$ mm
Galileo	$\approx 2$ m	$\approx 0.2$ m	$\approx 3$ cm	$\approx 5$ mm	$\approx 1$ mm
IGSO/GEO	$< 1$ m	$\approx 5$ cm	$< 5$ mm	$\approx 1$ mm	—

3D-RMS of the orbit differences w.r.t. an orbit based on a gravity field expanded up to degree and order 20.

- for **MEO satellites** the gravity field needs to be considered up to **degree and order 7**,
- whereas for satellites in the higher **IGSO or GEO** a expansion up to **degree and order 5** is sufficient.

# The Earth is not Spherically Symmetric

---

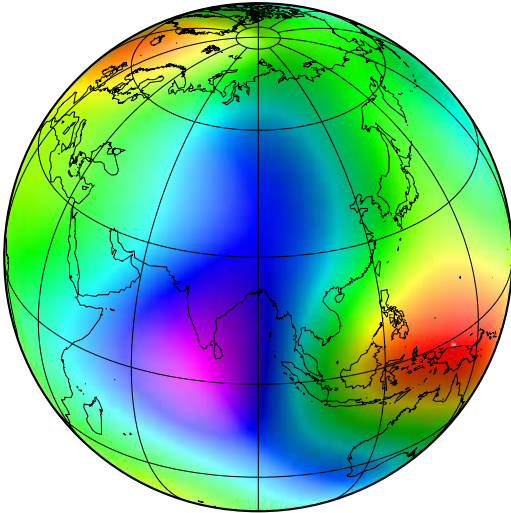

Resolution of the Earth gravity field relevant for modelling the orbits of GNSS satellites in MEO orbits.

# The Earth is not Spherically Symmetric

---

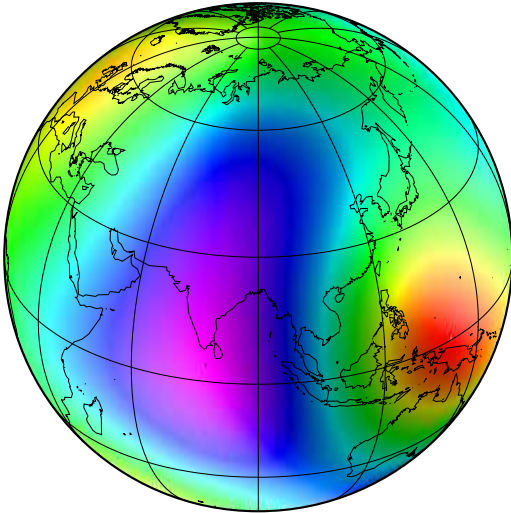

Resolution of the Earth gravity field relevant for modelling the orbits of GNSS satellites in IGSO/GEO orbits.

# Gravitational Forces

---

## Summary:

- All relevant masses acting on a GNSS satellite must be known (including their location).

# Gravitational Forces

---

## Summary:

- All relevant masses acting on a GNSS satellite must be known (including their location).
- The gravitational effects on the satellite can be computed based on the gravitational law.

# Gravitational Forces

---

## Summary:

- All relevant masses acting on a GNSS satellite must be known (including their location).
- The gravitational effects on the satellite can be computed based on the gravitational law.
- The effects of the individual masses have to be summed up.



# Gravitational Forces

---

## Summary:

- All relevant masses acting on a GNSS satellite must be known (including their location).
- The gravitational effects on the satellite can be computed based on the gravitational law.
- The effects of the individual masses have to be summed up.
- Regarding the body Earth even a more detailed distribution of the masses need to be considered.

# Gravitational Forces

---

The most relevant gravitational effects for GNSS orbit modelling:

- **Oblateness of the Earth**

GPS:  $\approx 40$  km

Galileo:  $\approx 27$  km

QZSS:  $\approx 15$  km

# Gravitational Forces

---

The most relevant gravitational effects for GNSS orbit modelling:

- **Oblateness of the Earth**

GPS:  $\approx 40$  km

Galileo:  $\approx 27$  km

QZSS:  $\approx 15$  km

- **Lunar gravitational attraction**

GPS:  $\approx 1.5$  km

Galileo:  $\approx 3$  km

QZSS:  $\approx 5$  km

# Gravitational Forces

---

The most relevant gravitational effects for GNSS orbit modelling:

- **Oblateness of the Earth**

GPS:  $\approx 40$  km

Galileo:  $\approx 27$  km

QZSS:  $\approx 15$  km

- **Lunar gravitational attraction**

GPS:  $\approx 1.5$  km

Galileo:  $\approx 3$  km

QZSS:  $\approx 5$  km

- **Solar gravitational attraction**

GPS:  $\approx 1$  km

Galileo:  $\approx 2$  km

QZSS:  $\approx 6$  km

Maximal influence of the effect on the orbit after one day of orbit integration.

# Gravitational Forces

---

The most relevant gravitational effects for GNSS orbit modelling:

- **Oblateness of the Earth**

GPS:  $\approx 40$  km

Galileo:  $\approx 27$  km

QZSS:  $\approx 15$  km

- **Lunar gravitational attraction**

GPS:  $\approx 1.5$  km

Galileo:  $\approx 3$  km

QZSS:  $\approx 5$  km

- **Solar gravitational attraction**

GPS:  $\approx 1$  km

Galileo:  $\approx 2$  km

QZSS:  $\approx 6$  km

- **Earth gravity field (remaining parts)**

GPS:  $\approx 500$  m

Galileo:  $\approx 300$  m

QZSS:  $\approx 200$  m

Maximal influence of the effect on the orbit after one day of orbit integration.

# Gravitational Forces

---

The most relevant gravitational effects for GNSS orbit modelling:

- **Oblateness of the Earth**

GPS:  $\approx 40$  km

Galileo:  $\approx 27$  km

QZSS:  $\approx 15$  km

- **Lunar gravitational attraction**

GPS:  $\approx 1.5$  km

Galileo:  $\approx 3$  km

QZSS:  $\approx 5$  km

- **Solar gravitational attraction**

GPS:  $\approx 1$  km

Galileo:  $\approx 2$  km

QZSS:  $\approx 6$  km

- **Earth gravity field (remaining parts)**

GPS:  $\approx 500$  m

Galileo:  $\approx 300$  m

QZSS:  $\approx 200$  m

- **Gravitational effect due to ocean tides**

GPS:  $< 1$  cm

Galileo:  $< 5$  mm

QZSS:  $\approx 1$  mm

Maximal influence of the effect on the orbit after one day of orbit integration.

# Effects Acting on Satellites and Related Models

---

## Effects Acting on Satellites and Related Models

Gravitational Forces

Radiation Pressure Effects

Emmission Effects

# Radiation Pressure

---

According to **quantum mechanics**, each **photon** of frequency  $\nu$  and wavelength  $\lambda = \frac{c}{\nu}$  carries the **energy**

$$E = h \cdot \nu$$



# Radiation Pressure

---

According to **quantum mechanics**, each **photon** of frequency  $\nu$  and wavelength  $\lambda = \frac{c}{\nu}$  carries the **energy**

$$E = h \cdot \nu$$

and **linear momentum**

$$\vec{p} = \frac{h \cdot \nu}{c},$$

where

$c$  is the speed of light and  
 $h = 6.62 \cdot 10^{-34}$  Js is Planck's constant.

# Radiation Pressure

---

According to **quantum mechanics**, each **photon** of frequency  $\nu$  and wavelength  $\lambda = \frac{c}{\nu}$  carries the **energy**

$$E = h \cdot \nu$$

and **linear momentum**

$$\vec{p} = \frac{h \cdot \nu}{c},$$

where

$c$  is the speed of light and  
 $h = 6.62 \cdot 10^{-34} \text{ Js}$  is **Planck's constant**.

# Radiation Pressure

---

According to **quantum mechanics**, each **photon** of frequency  $\nu$  and wavelength  $\lambda = \frac{c}{\nu}$  carries the **energy**

$$E = h \cdot \nu$$

and **linear momentum**

$$\vec{p} = \frac{h \cdot \nu}{c},$$

where

$c$  is the speed of light and  
 $h = 6.62 \cdot 10^{-34}$  Js is Planck's constant.

An **interaction of radiation** with a surface causes an exchange of momentum and **therefore a force**.

# Direct Radiation Pressure from the Sun

---

For the orbit modelling we need the resulting acceleration:

$$\vec{a}_{SRP} = \vec{C} \cdot \frac{(1 \text{ AU})^2}{|\vec{r}_{sat} - \vec{r}_{Sun}|^2} \cdot \frac{\Phi}{c} \cdot \frac{A_{sat}}{m_{sat}}$$

where

$\vec{C}$  is the vectorial radiation pressure coefficient (on the optical properties of the surface),  
 $A_{sat}$  is the area of the surface,  
 $m_{sat}$  is the mass of the satellite,  
 $\Phi \approx 1367 \frac{\text{W}}{\text{m}^2}$  is the solar flux (the energy passing through a unit area in a unit time) at the distance of 1 AU, and accounts for changes in the solar flux due to the eccentricity of the Earth's orbits around the Sun.

# Direct Radiation Pressure from the Sun

---

For the orbit modelling we need the resulting acceleration:

$$\vec{a}_{SRP} = \vec{C} \cdot \frac{(1 \text{ AU})^2}{|\vec{r}_{sat} - \vec{r}_{Sun}|^2} \cdot \frac{\Phi}{c} \cdot \frac{A_{sat}}{m_{sat}}$$

where

$\vec{C}$  is the vectorial radiation pressure coefficient (on the optical properties of the surface),  
 $A_{sat}$  is the area of the surface,  
 $m_{sat}$  is the mass of the satellite,  
 $\Phi \approx 1367 \frac{\text{W}}{\text{m}^2}$  is the solar flux (the energy passing through a unit area in a unit time) at the distance of 1 AU, and accounts for changes in the solar flux due to the eccentricity of the Earth's orbits around the Sun.  
 $\frac{(1 \text{ AU})^2}{|\vec{r}_{sat} - \vec{r}_{Sun}|^2}$

# Direct Radiation Pressure from the Sun

---

For the orbit modelling we need the resulting acceleration:

$$\vec{a}_{SRP} = \vec{C} \cdot \frac{(1 \text{ AU})^2}{|\vec{r}_{sat} - \vec{r}_{Sun}|^2} \cdot \frac{\Phi}{c} \cdot \frac{A_{sat}}{m_{sat}}$$

where

$\vec{C}$  is the vectorial radiation pressure coefficient (on the optical properties of the surface),  
 $A_{sat}$  is the area of the surface,  
 $m_{sat}$  is the mass of the satellite,  
 $\Phi \approx 1367 \frac{\text{W}}{\text{m}^2}$  is the solar flux (the energy passing through a unit area in a unit time) at the distance of 1 AU, and  
 $\frac{(1 \text{ AU})^2}{|\vec{r}_{sat} - \vec{r}_{Sun}|^2}$  accounts for changes in the solar flux due to the eccentricity of the Earth's orbits around the Sun.

# Direct Radiation Pressure from the Sun

---

For the orbit modelling we need the resulting acceleration:

$$\vec{a}_{SRP} = \vec{C} \cdot \frac{(1 \text{ AU})^2}{|\vec{r}_{sat} - \vec{r}_{Sun}|^2} \cdot \frac{\Phi}{c} \cdot \frac{A_{sat}}{m_{sat}}$$

where

$\vec{C}$  is the **vectorial radiation pressure coefficient** (on the optical properties of the surface),

$A_{sat}$  is the area of the surface,

$m_{sat}$  is the mass of the satellite,

$\Phi \approx 1367 \frac{\text{W}}{\text{m}^2}$  is the solar flux (the energy passing through a unit area in a unit time) at the distance of 1 AU, and

$\frac{(1 \text{ AU})^2}{|\vec{r}_{sat} - \vec{r}_{Sun}|^2}$  accounts for changes in the solar flux due to the eccentricity of the Earth's orbits around the Sun.

# Direct Radiation Pressure from the Sun

---

For the orbit modelling we need the resulting acceleration:

$$\vec{a}_{SRP} = \vec{C} \cdot \frac{(1 \text{ AU})^2}{|\vec{r}_{sat} - \vec{r}_{Sun}|^2} \cdot \frac{\Phi}{c} \cdot \frac{A_{sat}}{m_{sat}}$$

where

$\vec{C}$  is the vectorial radiation pressure coefficient (on the optical properties of the surface),

$A_{sat}$  is the **area of the surface**,

$m_{sat}$  is the **mass of the satellite**,

$\Phi \approx 1367 \frac{\text{W}}{\text{m}^2}$  is the solar flux (the energy passing through a unit area in a unit time) at the distance of 1 AU, and accounts for changes in the solar flux due to the eccentricity of the Earth's orbits around the Sun.



# Direct Radiation Pressure from the Sun

---

For the orbit modelling we need the resulting acceleration:

$$\vec{a}_{SRP} = \vec{C} \cdot \frac{(1 \text{ AU})^2}{|\vec{r}_{sat} - \vec{r}_{Sun}|^2} \cdot \frac{\Phi}{c} \cdot \frac{A_{sat}}{m_{sat}}$$

where

$\vec{C}$  is the vectorial radiation pressure coefficient (on the optical properties of the surface),  
 $A_{sat}$  is the area of the surface,  
 $m_{sat}$  is the mass of the satellite,  
 $\Phi \approx 1367 \frac{\text{W}}{\text{m}^2}$  is the solar flux (the energy passing through a unit area in a unit time) at the distance of 1 AU, and  
 $\frac{(1 \text{ AU})^2}{|\vec{r}_{sat} - \vec{r}_{Sun}|^2}$  accounts for changes in the solar flux due to the eccentricity of the Earth's orbits around the Sun.

The direction of the resulting acceleration depends on the kind of interaction of the radiation with the surface.

# Interaction of a Photon with a Surface

---

## Specular reflection:

As the photon is specularly reflected from the surface,

# Interaction of a Photon with a Surface

---

## Specular reflection:

As the photon is specularly reflected from the surface,

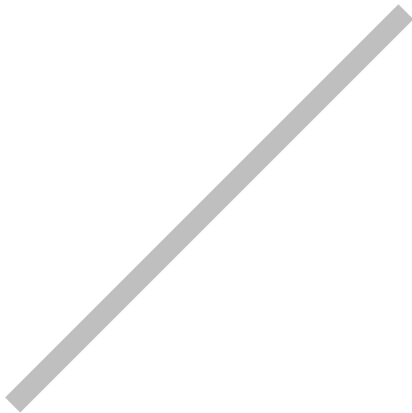

# Interaction of a Photon with a Surface

---

## Specular reflection:

As the photon is specularly reflected from the surface,

normal vector  
to the surface

$\vec{n}$

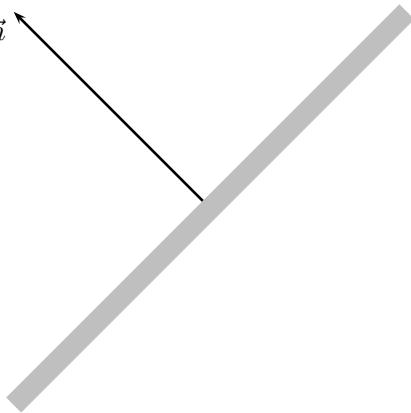

# Interaction of a Photon with a Surface

---

## Specular reflection:

As the photon is specularly reflected from the surface,

normal vector  
to the surface

$\vec{n}$

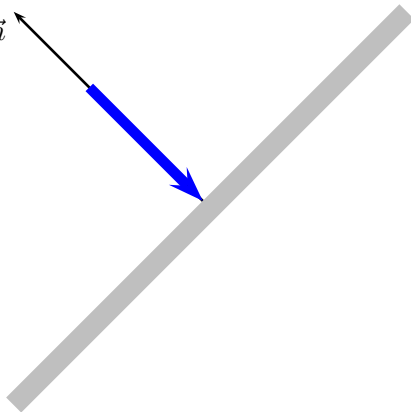

# Interaction of a Photon with a Surface

---

## Specular reflection:

As the photon is specularly reflected from the surface,

normal vector  
to the surface

$\vec{n}$

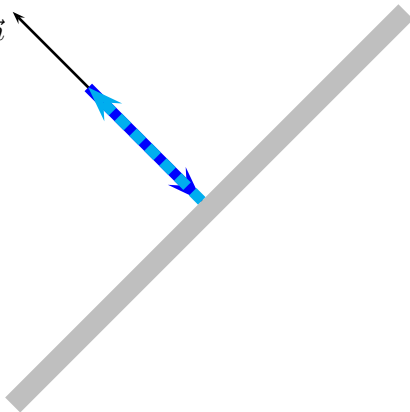

# Interaction of a Photon with a Surface

---

## Specular reflection:

As the photon is specularly reflected from the surface,

normal vector  
to the surface

$\vec{n}$

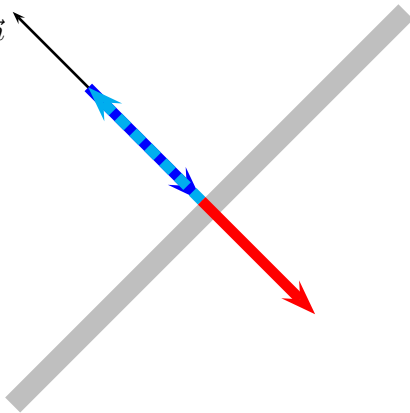

# Interaction of a Photon with a Surface

## Specular reflection:

As the photon is specularly reflected from the surface,

normal vector  
to the surface

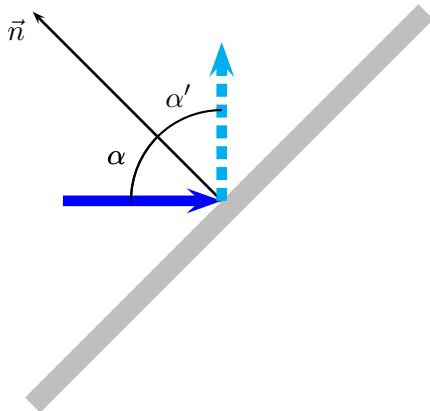



# Interaction of a Photon with a Surface

## Specular reflection:

As the photon is specularly reflected from the surface, only a **normal force** is produced:

$$\vec{C}_s = -2 \cdot \cos^2 \alpha \cdot \vec{n}$$

normal vector  
to the surface

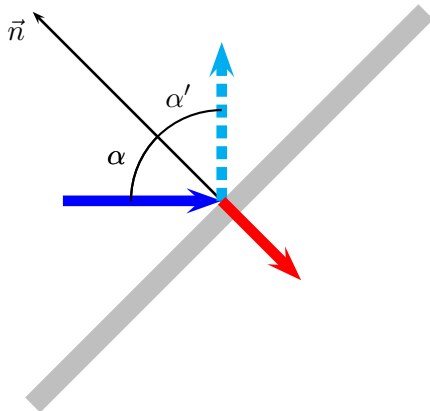

# Interaction of a Photon with a Surface

---

Diffuse reflection:

# Interaction of a Photon with a Surface

---

Diffuse reflection:

normal vector  
to the surface

$\vec{n}$

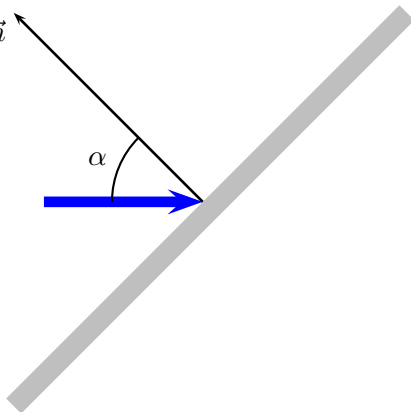

# Interaction of a Photon with a Surface

Diffuse reflection:

normal vector  
to the surface

$\vec{n}$

$\alpha$

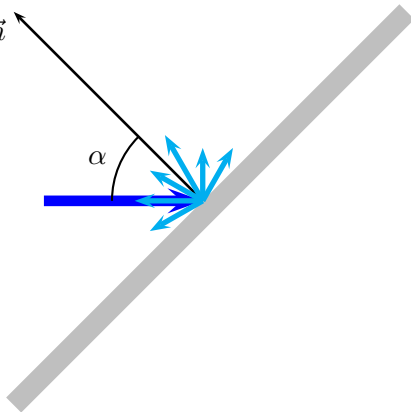

# Interaction of a Photon with a Surface

## Diffuse reflection:

This kind of reflection produces both normal and tangential forces:

$$\vec{C}_d = \left( \frac{\vec{r}_{sat} - \vec{r}_{Sun}}{|\vec{r}_{sat} - \vec{r}_{Sun}|} - \frac{2}{3} \vec{n} \right) \cdot \cos \alpha$$

(assuming diffuse reflection according to Lambert's cosine law)

normal vector  
to the surface

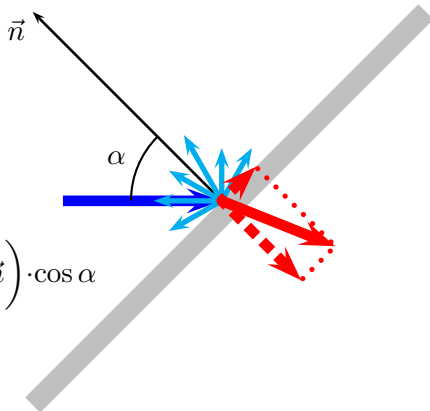

# Interaction of a Photon with a Surface

---

## Absorption:

The photon is fully absorbed by the surface.

# Interaction of a Photon with a Surface

---

## Absorption:

The photon is fully absorbed by the surface.

normal vector  
to the surface

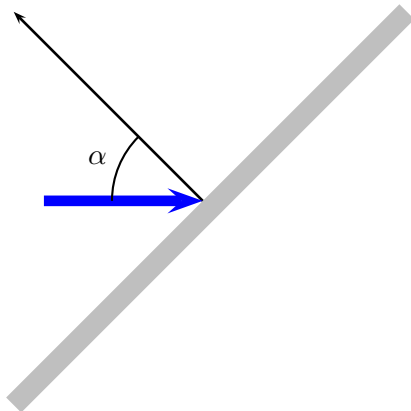

# Interaction of a Photon with a Surface

## Absorption:

The photon is fully absorbed by the surface.

normal vector  
to the surface

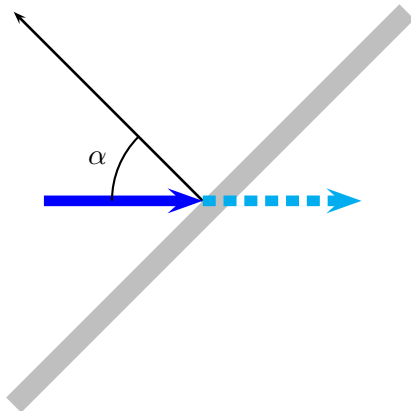



# Interaction of a Photon with a Surface

## Absorption:

The photon is fully absorbed by the surface. This produces both **normal** and **tangential** forces:

$$\vec{C}_a = \left( \frac{\vec{r}_{sat} - \vec{r}_{Sun}}{|\vec{r}_{sat} - \vec{r}_{Sun}|} \right) \cdot \cos \alpha$$

normal vector  
to the surface

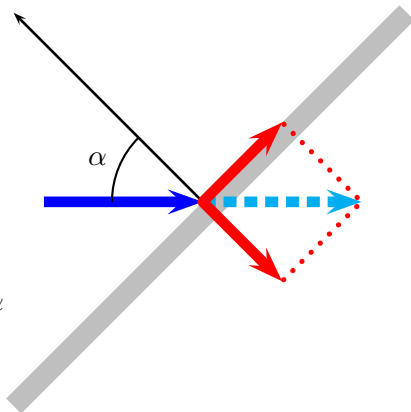

# Interaction of a Photon with a Surface

---

In general, realistic satellite surfaces show a **mixture of the three optical properties**. If

$p_s$  is the portion of **specularly reflected photons**,  
 $p_d$  is the portion of **diffusely reflected photons**, and  
 $(1 - p_d - p_s)$  is the portion of **absorbed photons**,

the **resulting radiation coefficient** is

$$\vec{C}_r = p_s \cdot \vec{C}_s + p_d \cdot \vec{C}_d + (1 - p_d - p_s) \cdot \vec{C}_a .$$

# Thermal Re-radiation Effect

---

The heat generated by the absorption (or any other **thermal emission of the satellite**) produces an additional force as a Lambert diffuser:

$$d\vec{F}_{therm} = -\frac{2}{3} \cdot \frac{\epsilon \sigma T_A^4}{c} dA \cdot \vec{e}_A$$

with

- $\epsilon$  is the emissivity,
- $\sigma$  the Stephan-Boltzmann constant,
- $c$  the speed of light,
- $T_A$  the temperature of the surface,
- $A$  the surface area, and
- $\vec{e}_A$  the unit vector normal to the emitting surface.

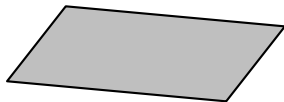

# Thermal Re-radiation Effect

The heat generated by the absorption (or any other **thermal emission of the satellite**) produces an additional force as a Lambert diffuser:

$$d\vec{F}_{therm} = -\frac{2}{3} \cdot \frac{\epsilon \sigma T_A^4}{c} dA \cdot \vec{e}_A$$

with

- $\epsilon$  is the emissivity,
- $\sigma$  the Stephan-Boltzmann constant,
- $c$  the speed of light,
- $T_A$  the temperature of the surface,
- $A$  the surface area, and
- $\vec{e}_A$  the unit vector normal to the emitting surface.

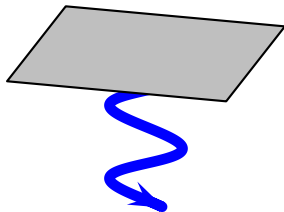

# Thermal Re-radiation Effect

The heat generated by the absorption (or any other **thermal emission of the satellite**) produces an additional force as a Lambert diffuser:

$$d\vec{F}_{therm} = -\frac{2}{3} \cdot \frac{\epsilon \sigma T_A^4}{c} dA \cdot \vec{e}_A$$

with

$\epsilon$  is the emissivity,  
 $\sigma$  the Stephan-Boltzmann constant,  
 $c$  the speed of light,  
 $T_A$  the temperature of the surface,  
 $A$  the surface area, and  
 $\vec{e}_A$  the unit vector normal to the emitting surface.

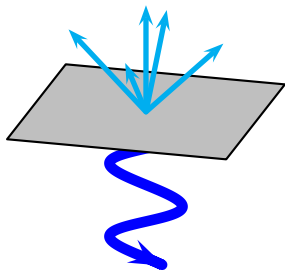

# Thermal Re-radiation Effect

The heat generated by the absorption (or any other **thermal emission of the satellite**) produces an additional force as a Lambert diffuser:

$$d\vec{F}_{therm} = -\frac{2}{3} \cdot \frac{\epsilon \sigma T_A^4}{c} dA \cdot \vec{e}_A$$

with

- $\epsilon$  is the emissivity,
- $\sigma$  the Stephan-Boltzmann constant,
- $c$  the speed of light,
- $T_A$  the temperature of the surface,
- $A$  the surface area, and
- $\vec{e}_A$  the unit vector normal to the emitting surface.

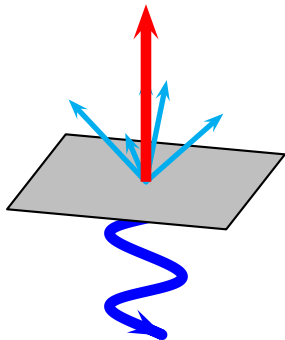

# Thermal Re-radiation Effect

The heat generated by the absorption (or any other **thermal emission of the satellite**) produces an additional force as a Lambert diffuser:

$$d\vec{F}_{therm} = -\frac{2}{3} \cdot \frac{\epsilon \sigma T_A^4}{c} dA \cdot \vec{e}_A$$

with

- $\epsilon$  is the emissivity,
- $\sigma$  the Stephan-Boltzmann constant,
- $c$  the speed of light,
- $T_A$  the **temperature of the surface**,
- $A$  the surface area, and
- $\vec{e}_A$  the unit vector normal to the emitting surface.

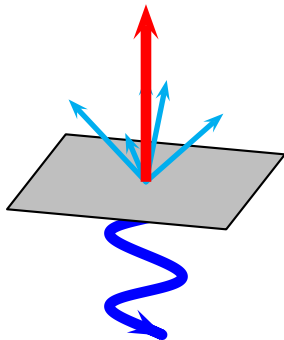

# Thermal Re-radiation Effect

The heat generated by the absorption (or any other **thermal emission of the satellite**) produces an additional force as a Lambert diffuser:

$$d\vec{F}_{therm} = -\frac{2}{3} \cdot \frac{\epsilon \sigma T_A^4}{c} dA \cdot \vec{e}_A$$

with

$\epsilon$  is the emissivity,  
 $\sigma$  the Stephan-Boltzmann constant,  
 $c$  the speed of light,  
 $T_A$  the temperature of the surface,  
 $A$  the **surface area**, and  
 $\vec{e}_A$  the **unit vector normal to the emitting surface**.

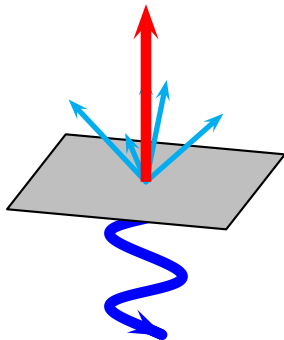



# Thermal Re-radiation Effect

The heat generated by the absorption (or any other **thermal emission of the satellite**) produces an additional force as a Lambert diffuser:

$$d\vec{F}_{therm} = -\frac{2}{3} \cdot \frac{\epsilon \sigma T_A^4}{c} dA \cdot \vec{e}_A$$

with

$\epsilon$  is the **emissivity**,  
 $\sigma$  the Stephan-Boltzmann constant,  
 $c$  the speed of light,  
 $T_A$  the temperature of the surface,  
 $A$  the surface area, and  
 $\vec{e}_A$  the unit vector normal to the emitting surface.

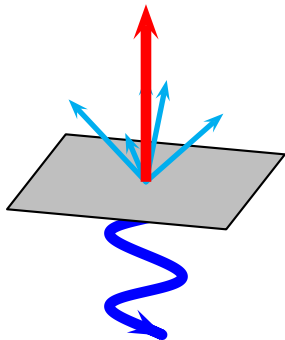

# Radiation Effects in the Orbit Determination

---

We need to know which amount of photons arrives at the satellite.  
According to the surface properties the resulting force can be derived.

# Radiation Effects in the Orbit Determination

---

We need to know which amount of photons arrives at the satellite.  
According to the surface properties the resulting force can be derived.



# Radiation Effects in the Orbit Determination

---

We need to know which amount of photons arrives at the satellite.  
According to the surface properties the resulting force can be derived.

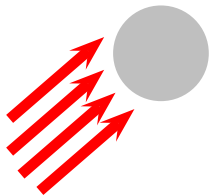

# Radiation Effects in the Orbit Determination

---

We need to know which amount of photons arrives at the satellite.  
According to the surface properties the resulting force can be derived.

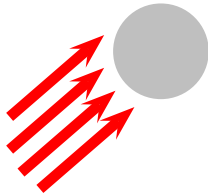

# Radiation Effects in the Orbit Determination

---

We need to know which amount of photons arrives at the satellite.  
According to the surface properties the resulting force can be derived.



# Analytical Modelling

---

For an analytical modelling of the radiation and re-radiation effects one needs

# Analytical Modelling

---

For an analytical modelling of the radiation and re-radiation effects one needs

- a detailed decomposition of the satellite into the **geometrical elements**,



# Analytical Modelling

---

For an analytical modelling of the radiation and re-radiation effects one needs

- a detailed decomposition of the satellite into the **geometrical elements**,
- the **optical properties** of all surfaces (including the consequences of aging effects),

# Analytical Modelling

---

For an analytical modelling of the radiation and re-radiation effects one needs

- a detailed decomposition of the satellite into the **geometrical elements**,
- the **optical properties** of all surfaces (including the consequences of aging effects),
- a reasonable knowledge about the **radiation** arriving at the satellite, and

# Analytical Modelling

---

For an analytical modelling of the radiation and re-radiation effects one needs

- a detailed decomposition of the satellite into the **geometrical elements**,
- the **optical properties** of all surfaces (including the consequences of aging effects),
- a reasonable knowledge about the **radiation** arriving at the satellite, and
- sufficient information about the **thermal conditions** of the satellite surfaces.

# Analytical Modelling

---

For an analytical modelling of the radiation and re-radiation effects one needs

- a detailed decomposition of the satellite into the **geometrical elements**,
- the **optical properties** of all surfaces (including the consequences of aging effects),
- a reasonable knowledge about the **radiation** arriving at the satellite, and
- sufficient information about the **thermal conditions** of the satellite surfaces.

With a **ray tracing** the resulting acceleration can be computed but this needs a **big computational effort**.

# Semi-Analytical Modelling

---



# Semi-Analytical Modelling

---

To reduce the computational effort, the satellite is typically represented by a **box-wing model**.



# Semi-Analytical Modelling

To reduce the computational effort, the satellite is typically represented by a **box-wing model**.

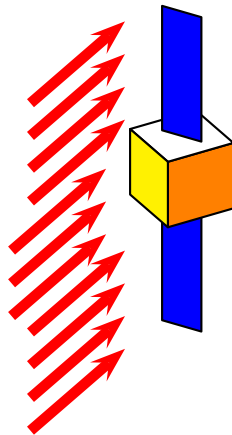

# Semi-Analytical Modelling

---

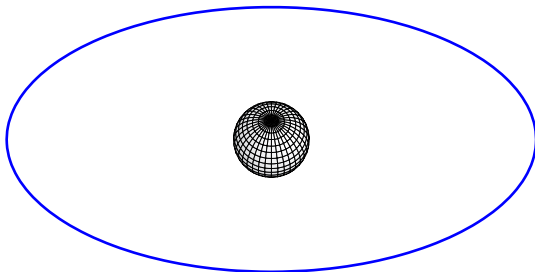



# Semi-Analytical Modelling

---

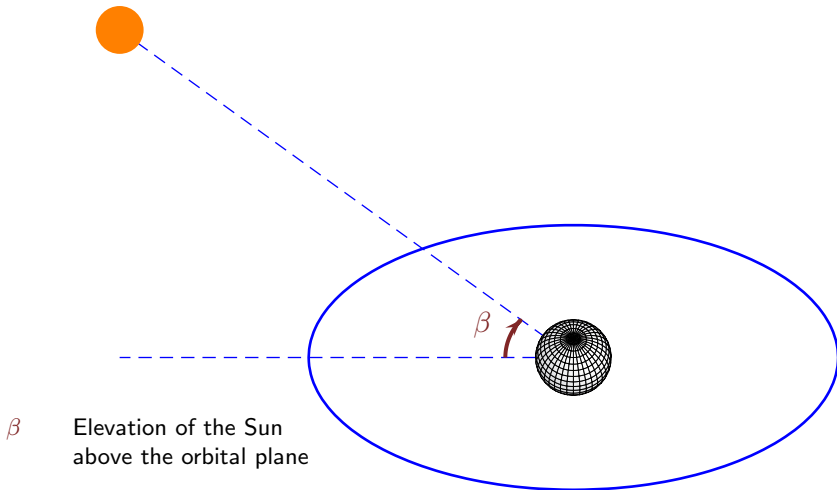

# Semi-Analytical Modelling

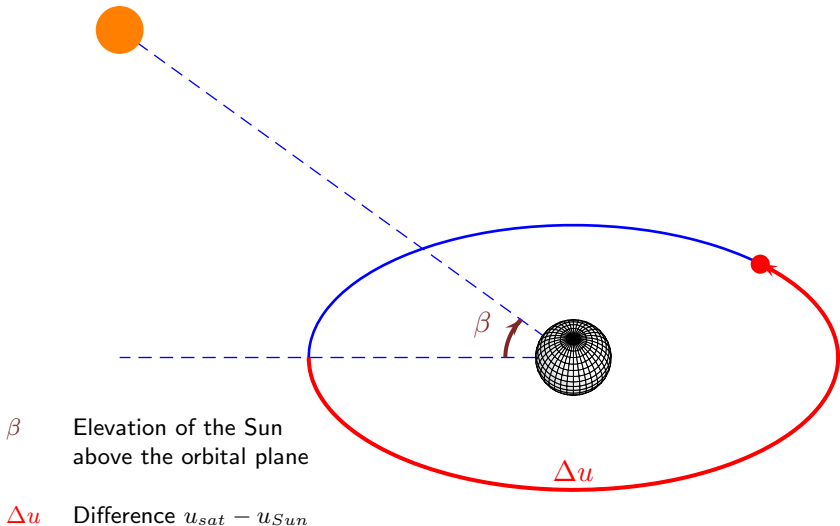

# Semi-Analytical Modelling

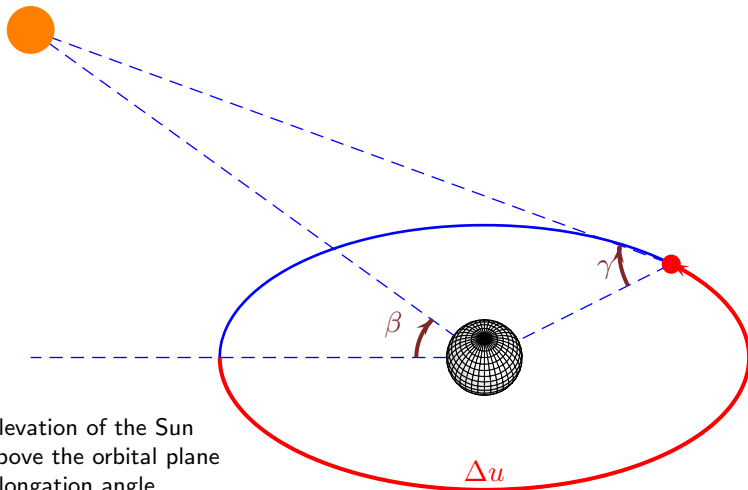

- $\beta$  Elevation of the Sun above the orbital plane
- $\gamma$  Elongation angle
- $\Delta u$  Difference  $u_{sat} - u_{Sun}$

# Semi-Analytical Modelling

$\vec{z}$  Direction satellite  $\rightarrow$  Earth  
(antenna pointing direction)

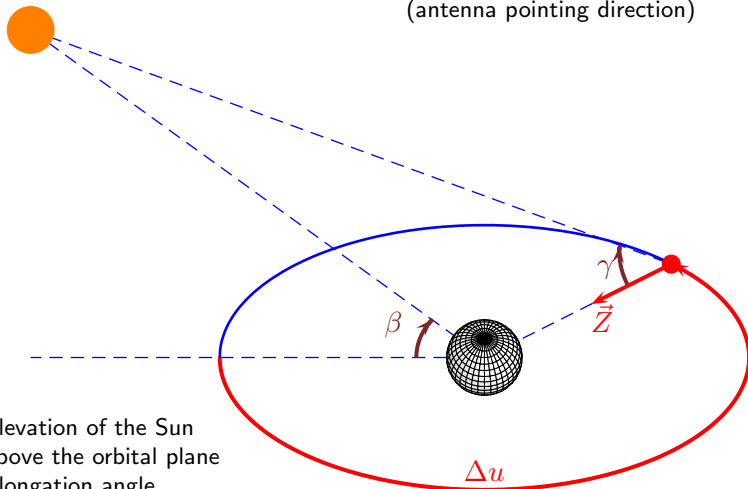

$\beta$  Elevation of the Sun  
above the orbital plane

$\gamma$  Elongation angle

$\Delta u$  Difference  $u_{sat} - u_{Sun}$

# Semi-Analytical Modelling

- $\vec{Z}$  Direction satellite  $\rightarrow$  Earth  
(antenna pointing direction)
- $\vec{D}$  Direction satellite  $\rightarrow$  Sun

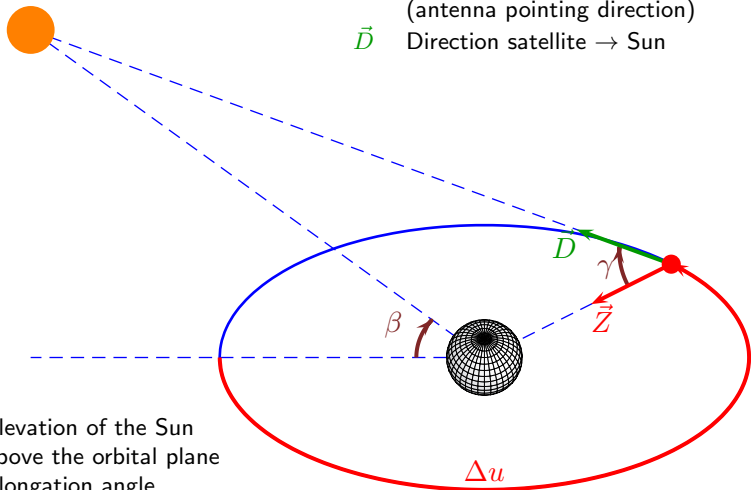

- $\beta$  Elevation of the Sun  
above the orbital plane
- $\gamma$  Elongation angle
- $\Delta u$  Difference  $u_{sat} - u_{Sun}$

# Semi-Analytical Modelling

- $\vec{Z}$  Direction satellite  $\rightarrow$  Earth  
(antenna pointing direction)
- $\vec{D}$  Direction satellite  $\rightarrow$  Sun
- $\vec{Y}$  Direction along the solar panel axis

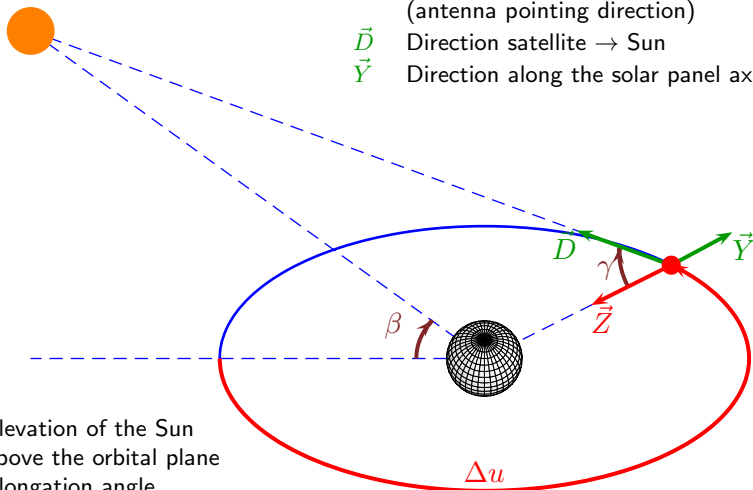

- $\beta$  Elevation of the Sun  
above the orbital plane
- $\gamma$  Elongation angle
- $\Delta u$  Difference  $u_{sat} - u_{Sun}$

# Semi-Analytical Modelling

- $\vec{Z}$  Direction satellite  $\rightarrow$  Earth  
(antenna pointing direction)
- $\vec{D}$  Direction satellite  $\rightarrow$  Sun
- $\vec{Y}$  Direction along the solar panel axis
- $\vec{B}$  Completes the system:  $\vec{B} = \vec{D} \times \vec{Y}$

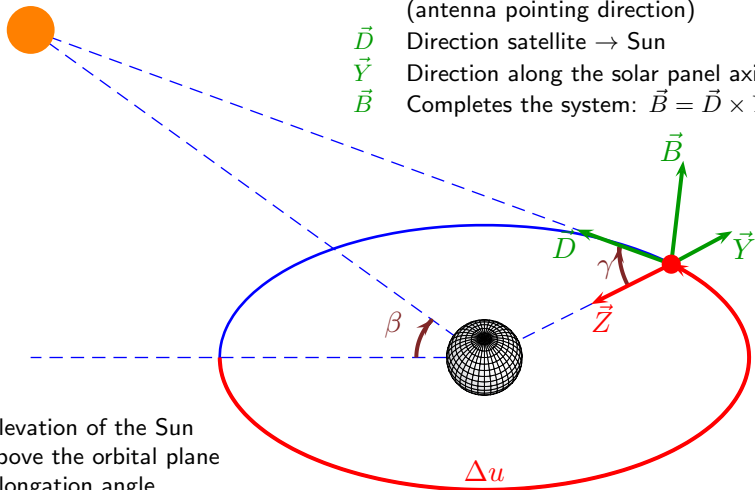

- $\beta$  Elevation of the Sun above the orbital plane
- $\gamma$  Elongation angle
- $\Delta u$  Difference  $u_{sat} - u_{Sun}$

# Semi-Analytical Modelling

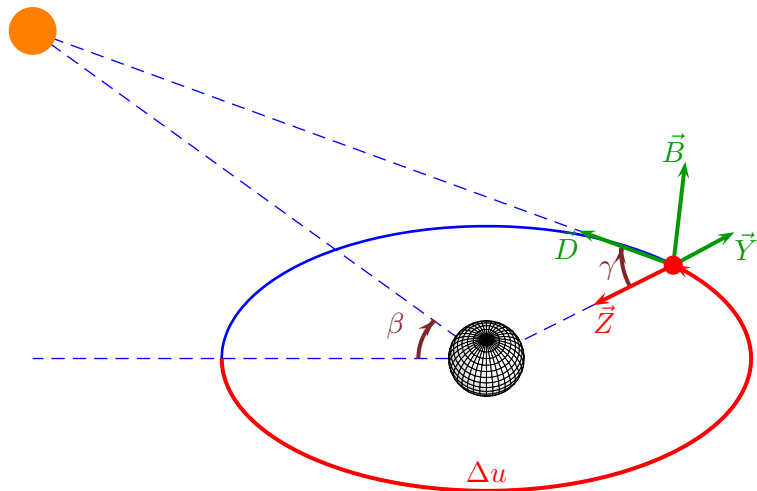



# Semi-Analytical Modelling

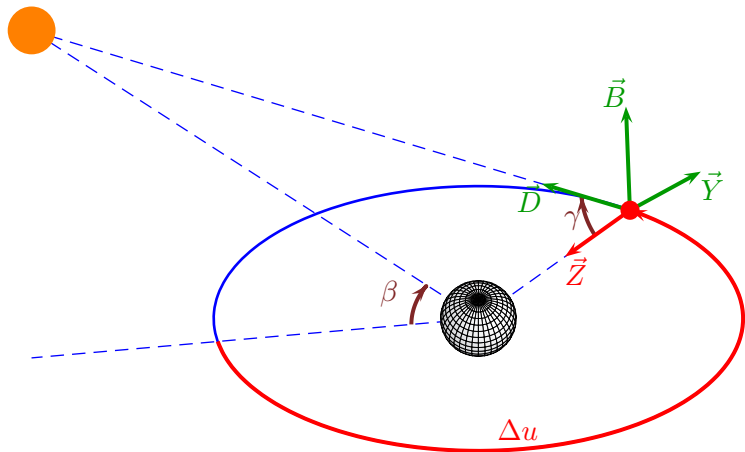

# Semi-Analytical Modelling

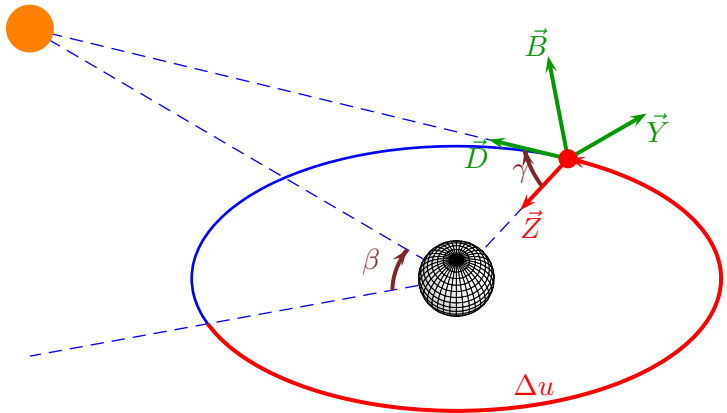

# Semi-Analytical Modelling

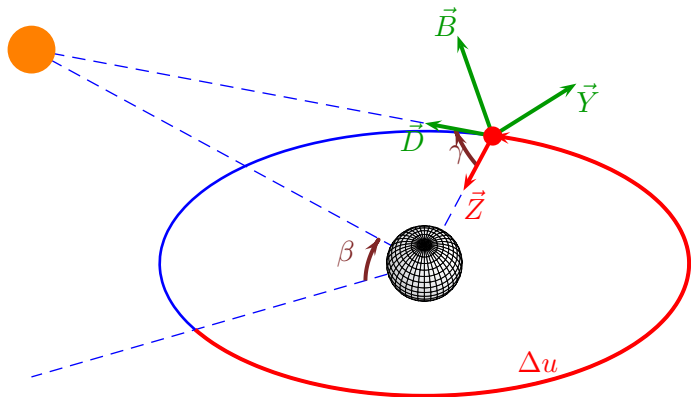

# Semi-Analytical Modelling

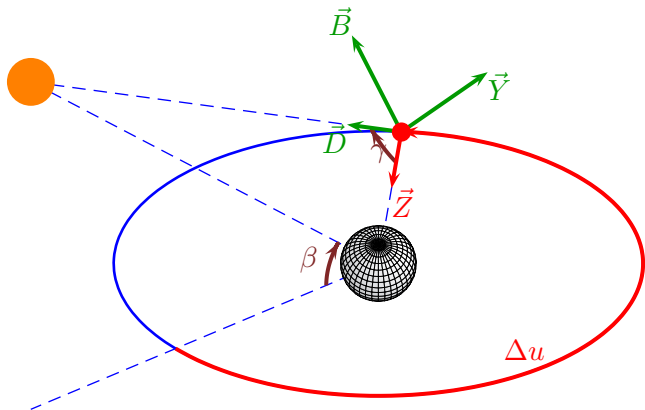

# Semi-Analytical Modelling

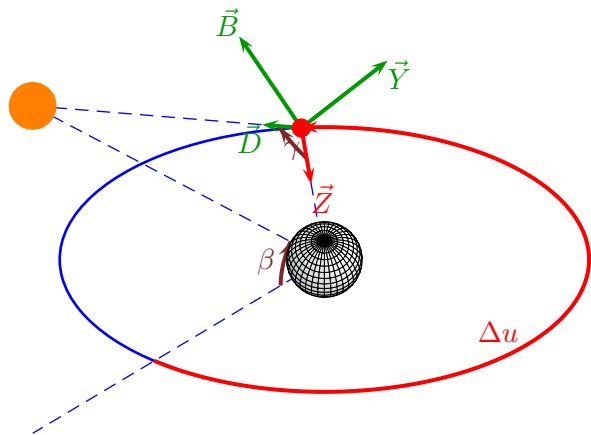

# Semi-Analytical Modelling

## Accelerations derived for GPS (Block IIA) satellites from a boxwing<sup>1</sup> and Rock-S<sup>2</sup> model

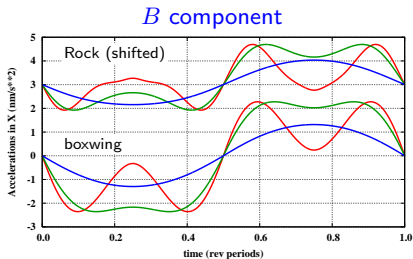
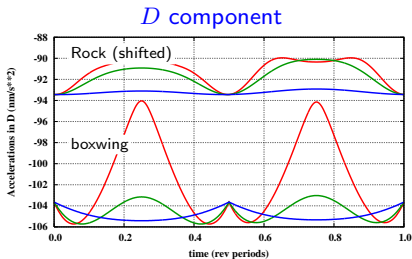

Computed for

$$\beta = 10^\circ$$

$$\beta = 45^\circ$$

$$\beta = 78^\circ$$

<sup>1</sup>as proposed by Carlos Rodriguez-Solano based on Fliegel et al. (1992)

<sup>2</sup>Fliegel et al. (1992)

# Semi-Analytical Modelling

---

If the radiation pressure effects cannot full be described by analytical models one has to adjust empirical [solar radiation pressure parameters](#).

# Semi-Analytical Modelling

---

If the radiation pressure effects cannot full be described by analytical models one has to adjust empirical **solar radiation pressure parameters**.

## **Adjustable box-wing model:**

C. Rodriguez-Solano has proposed to **directly adjust the effect** acting on the solar panels and the body of the satellite in the parameter adjustment.

These parameters are **highly correlated** and need a sophisticated system of constraints to become solvable.



# Semi-Analytical Modelling

---

If the radiation pressure effects cannot full be described by analytical models one has to adjust empirical **solar radiation pressure parameters**.

## **Adjustable box-wing model:**

C. Rodriguez-Solano has proposed to **directly adjust the effect** acting on the solar panels and the body of the satellite in the parameter adjustment.

These parameters are **highly correlated** and need a sophisticated system of constraints to become solvable.

## **Box-wing a priori model:**

A (more or less detailed) **radiation pressure model is introduced** in the orbit modelling process. **Empirical parameters** are estimated during the parameter adjustment process as well.

# Empirical Modelling

## Accelerations derived for GPS (Block IIA) satellites from a boxwing<sup>1</sup> and Rock-S<sup>2</sup> model

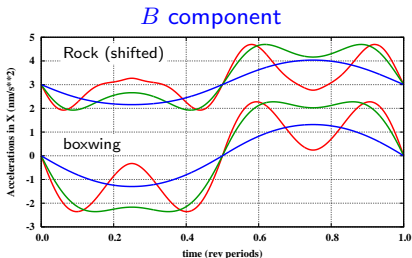
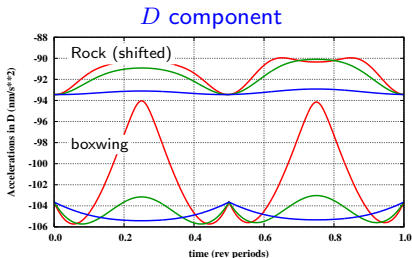

Computed for

$$\beta = 10^\circ$$

$$\beta = 45^\circ$$

$$\beta = 78^\circ$$

<sup>1</sup> as proposed by Carlos Rodriguez-Solano based on Fliegel et al. (1992)

<sup>2</sup> Fliegel et al. (1992)

# Empirical Modelling

## Accelerations derived for GPS (Block IIA) satellites from a boxwing<sup>1</sup> and Rock-S<sup>2</sup> model

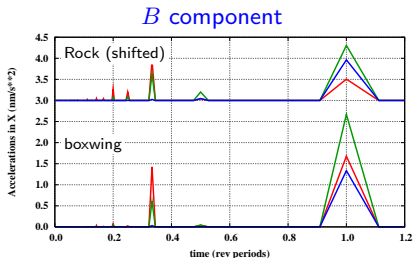
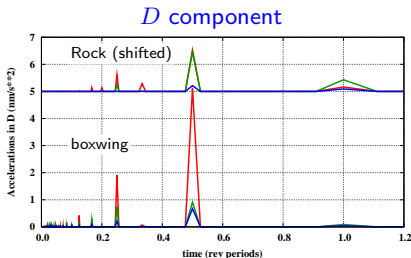

Computed for

$$\beta = 10^\circ$$

$$\beta = 45^\circ$$

$$\beta = 78^\circ$$

<sup>1</sup>as proposed by Carlos Rodriguez-Solano based on Fliegel et al. (1992)

<sup>2</sup>Fliegel et al. (1992)

# Observing the satellite from the Sun

---

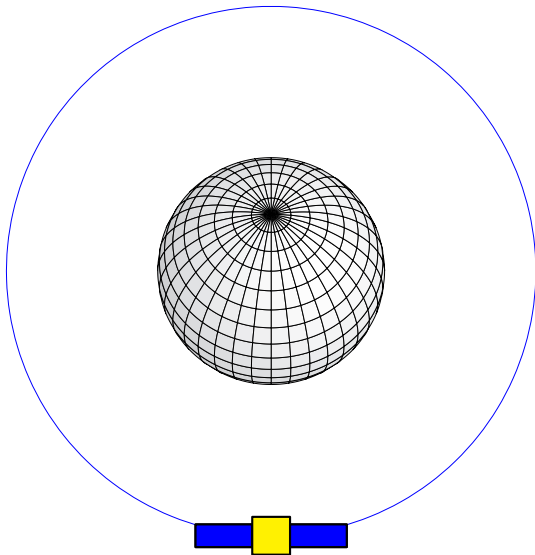

# Observing the satellite from the Sun

---

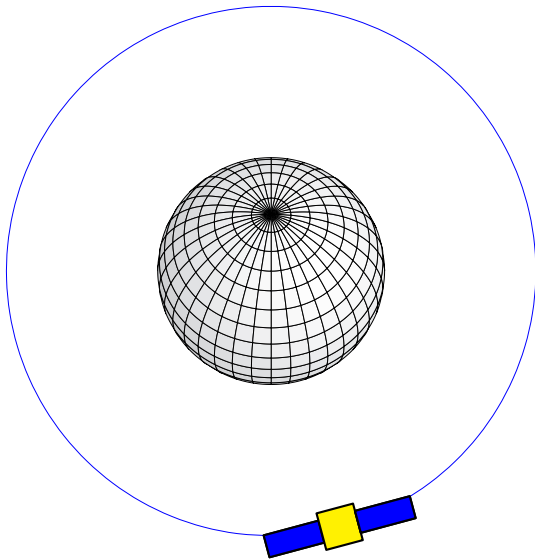

# Observing the satellite from the Sun

---

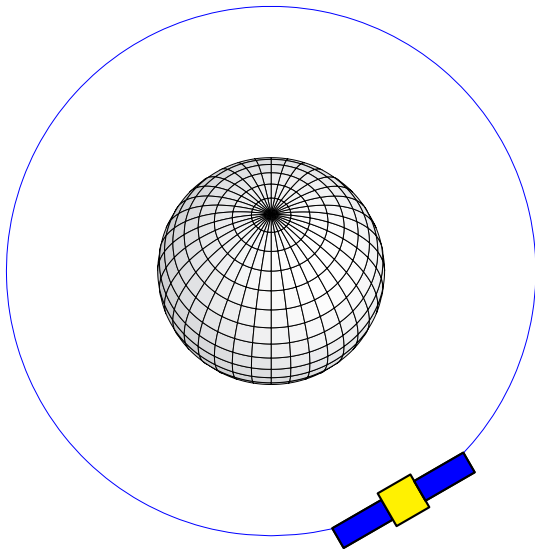

# Observing the satellite from the Sun

---

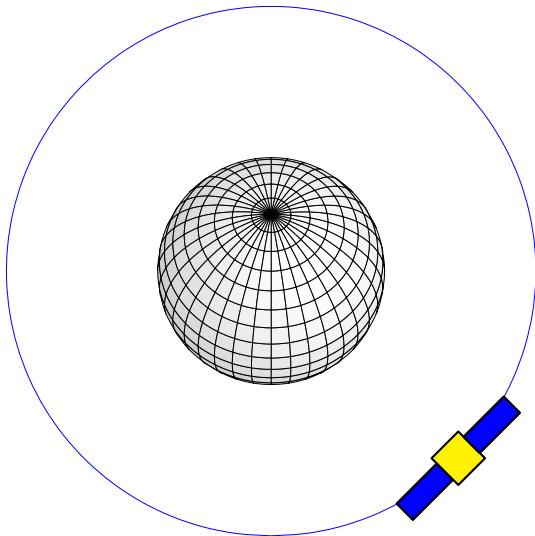

# Observing the satellite from the Sun

---

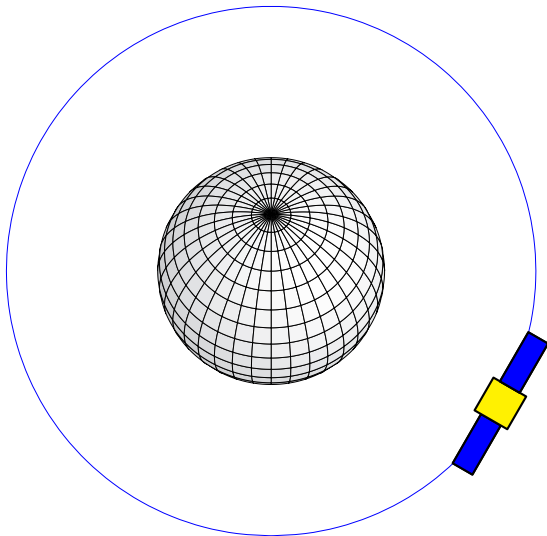



# Observing the satellite from the Sun

---

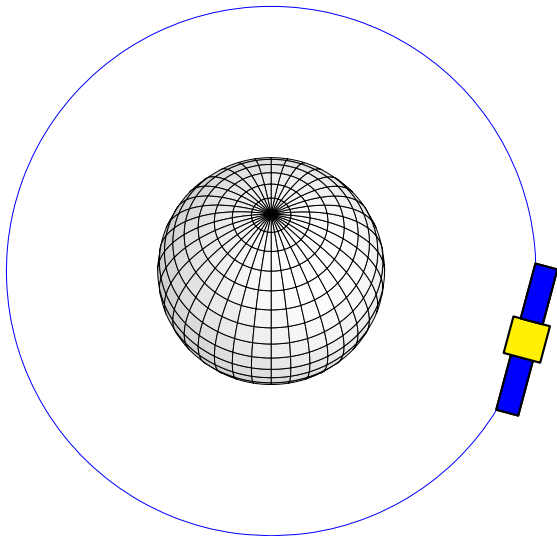

# Observing the satellite from the Sun

---

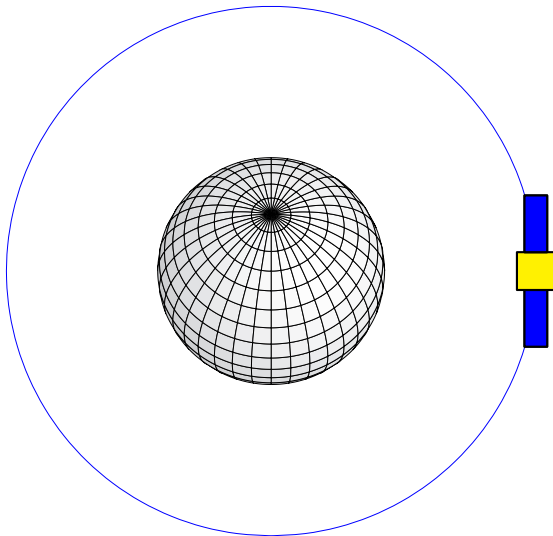

# Observing the satellite from the Sun

---

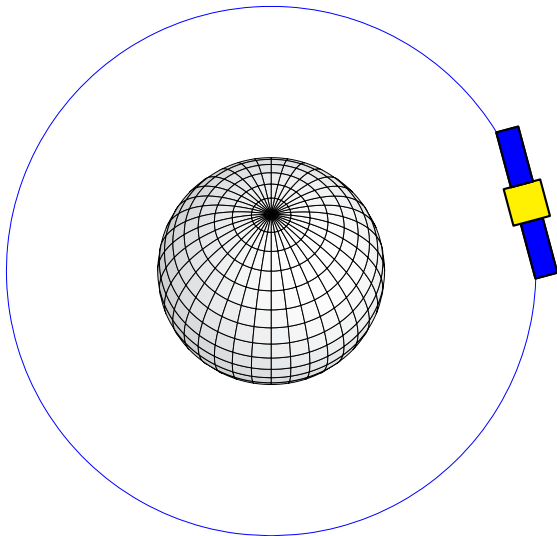

# Observing the satellite from the Sun

---

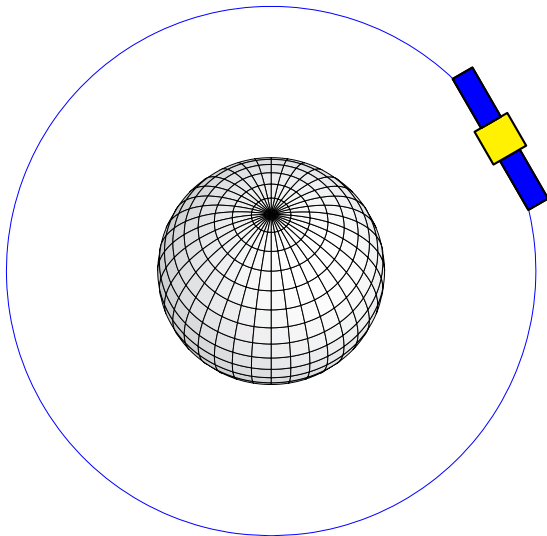

# Observing the satellite from the Sun

---

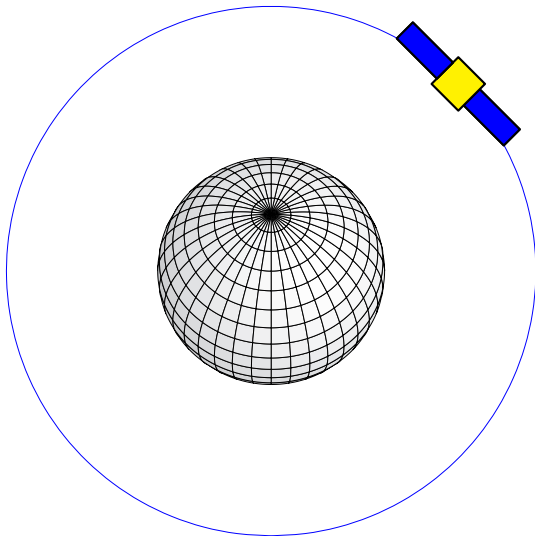

# Observing the satellite from the Sun

---

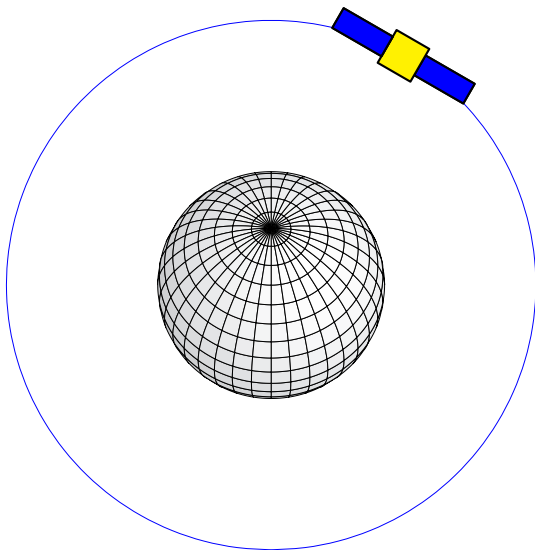

# Observing the satellite from the Sun

---

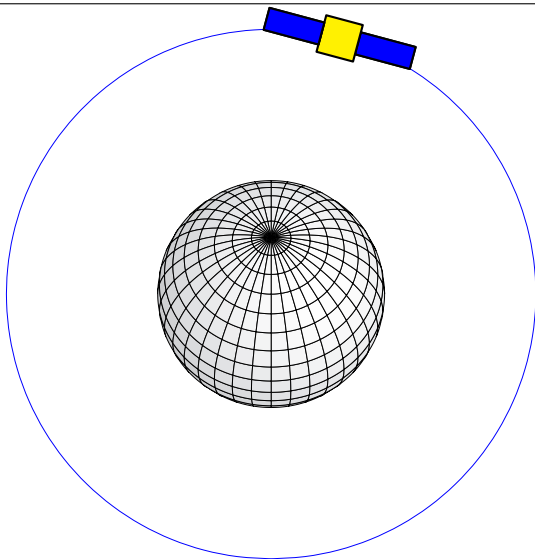

# Observing the satellite from the Sun

---

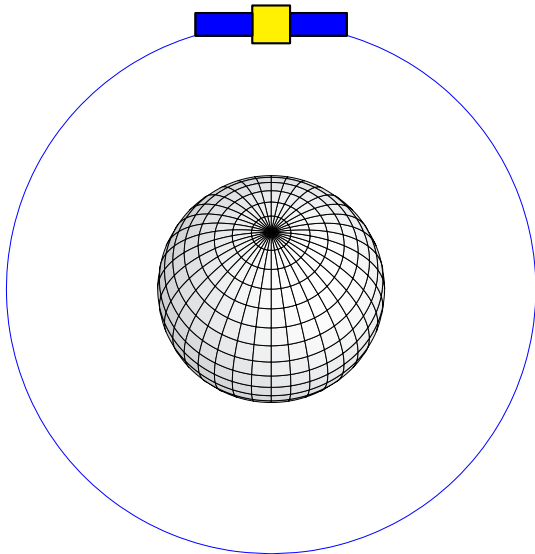



# Observing the satellite from the Sun

---

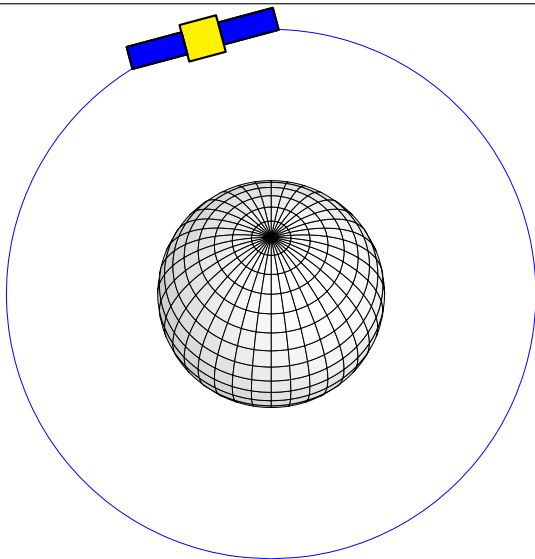

# Observing the satellite from the Sun

---

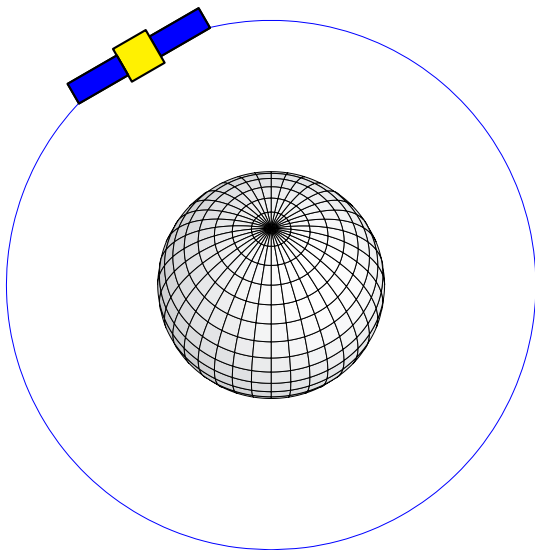

# Observing the satellite from the Sun

---

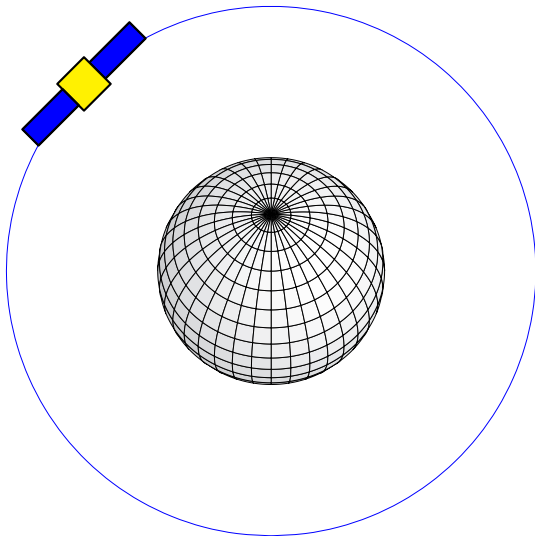

# Observing the satellite from the Sun

---

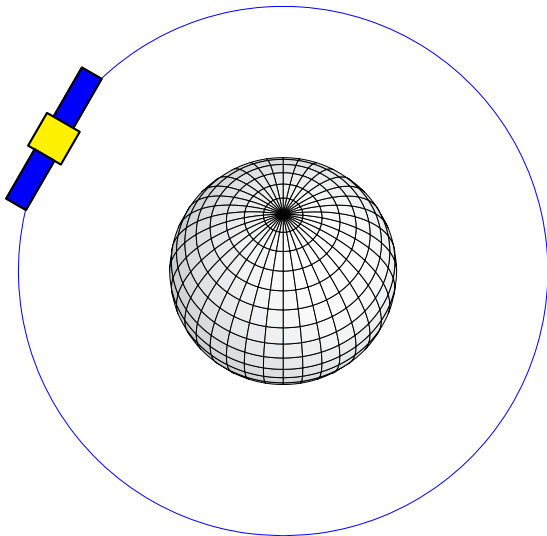

# Observing the satellite from the Sun

---

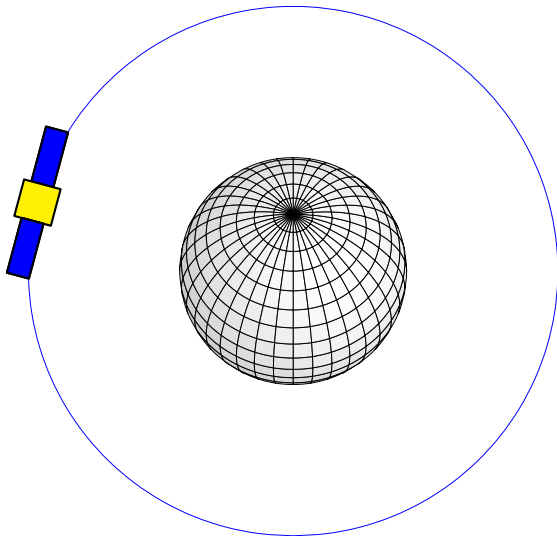

# Observing the satellite from the Sun

---

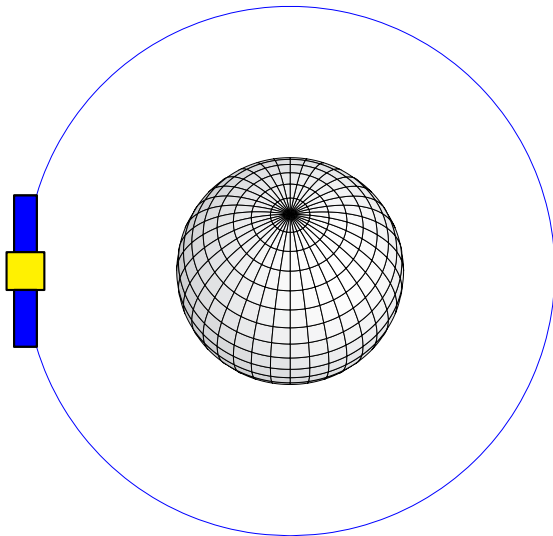

# Observing the satellite from the Sun

---

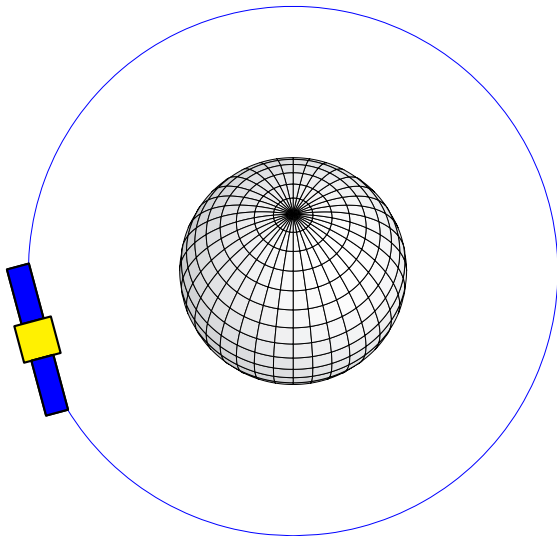

# Observing the satellite from the Sun

---

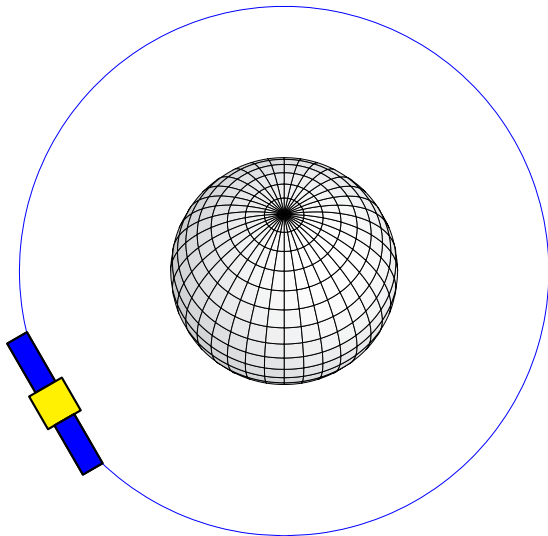



# Observing the satellite from the Sun

---

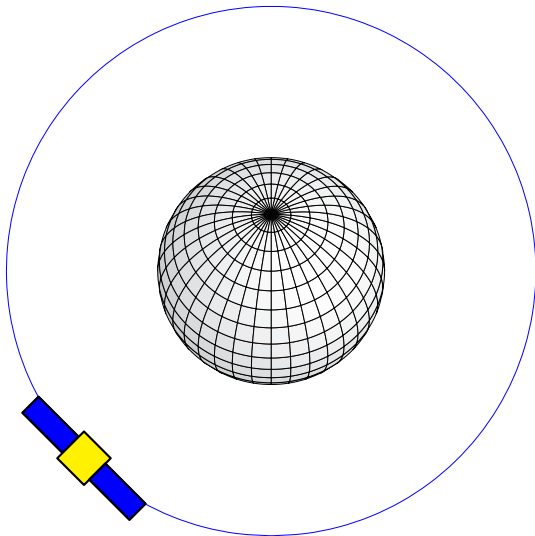

# Observing the satellite from the Sun

---

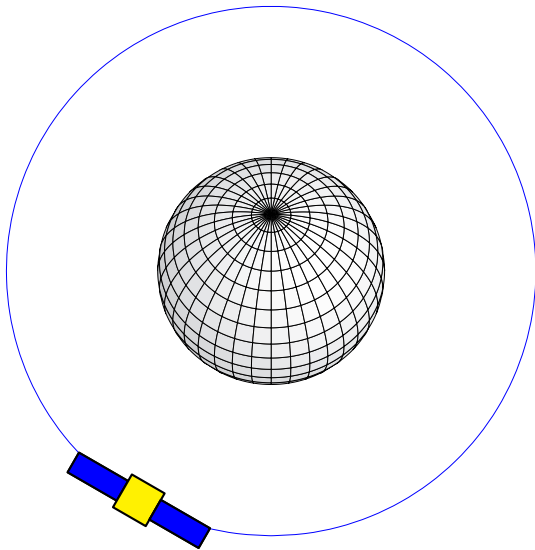

# Observing the satellite from the Sun

---

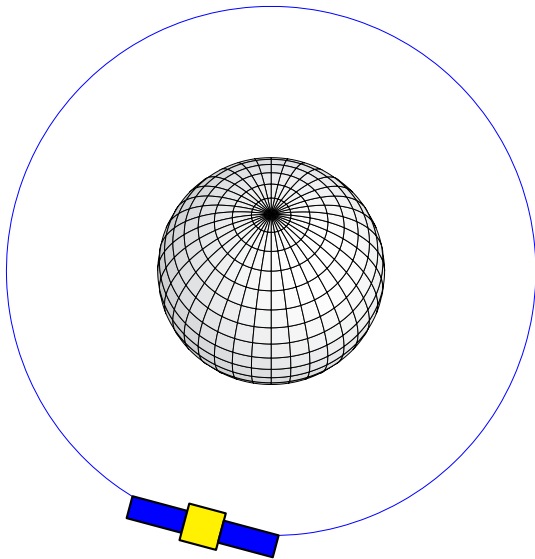

# Observing the satellite from the Sun

---

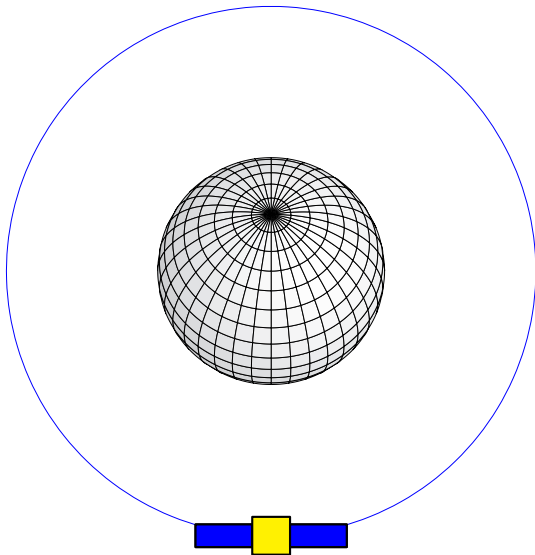

# Observing the satellite from the Sun

---

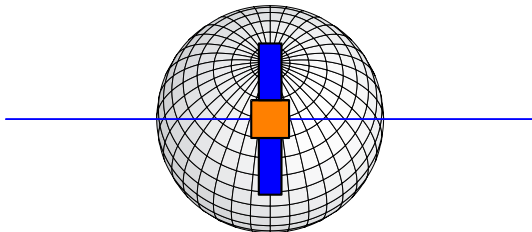

# Observing the satellite from the Sun

---

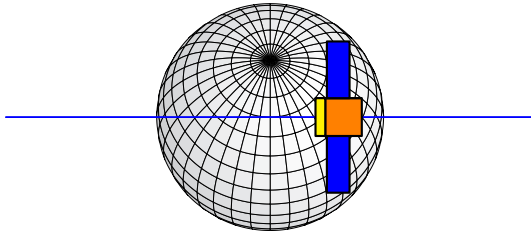

# Observing the satellite from the Sun

---

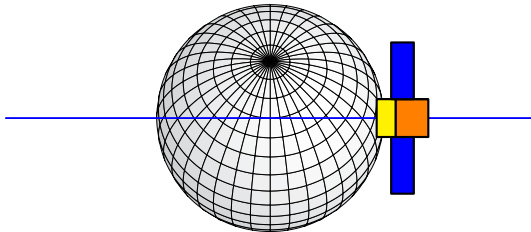

# Observing the satellite from the Sun

---

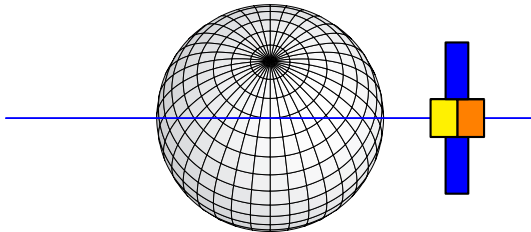



# Observing the satellite from the Sun

---

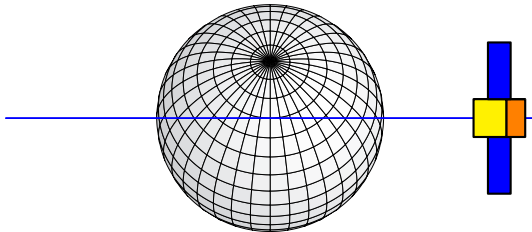

# Observing the satellite from the Sun

---

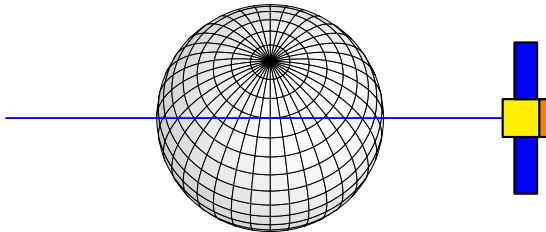

# Observing the satellite from the Sun

---

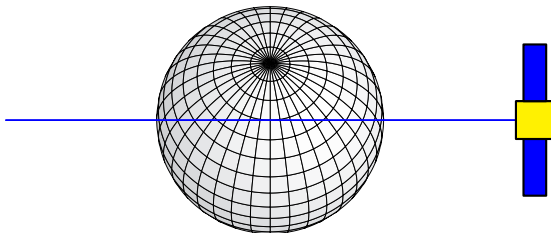

# Observing the satellite from the Sun

---

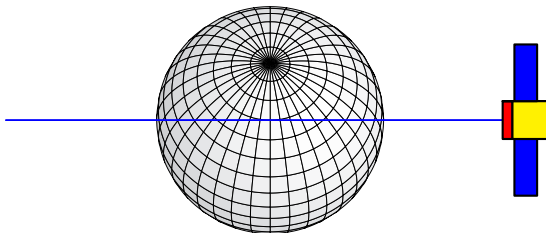

# Observing the satellite from the Sun

---

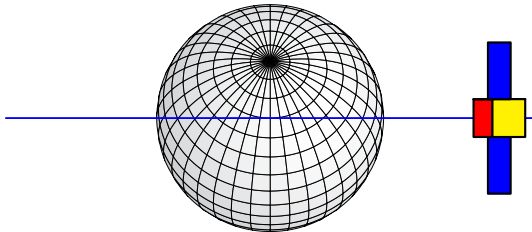

# Observing the satellite from the Sun

---

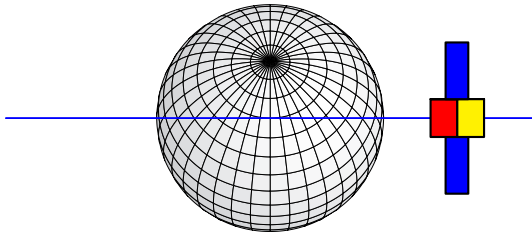

# Observing the satellite from the Sun

---

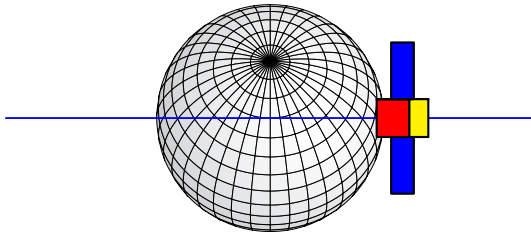

# Observing the satellite from the Sun

---

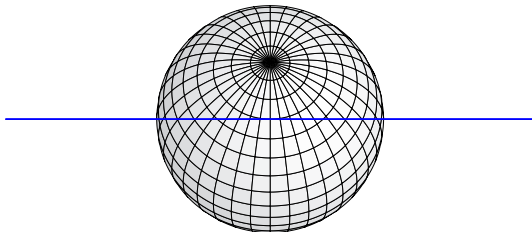



# Observing the satellite from the Sun

---

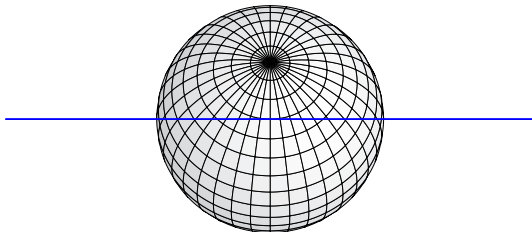

# Observing the satellite from the Sun

---

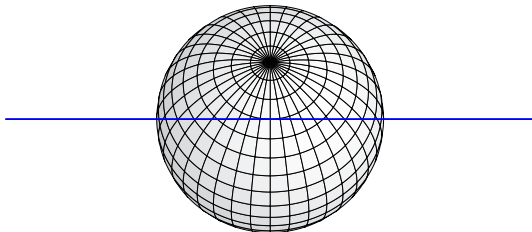

# Observing the satellite from the Sun

---

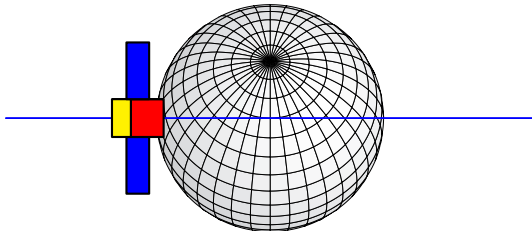

# Observing the satellite from the Sun

---

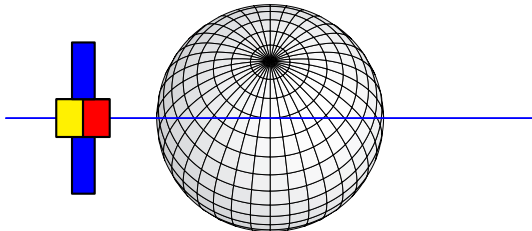

# Observing the satellite from the Sun

---

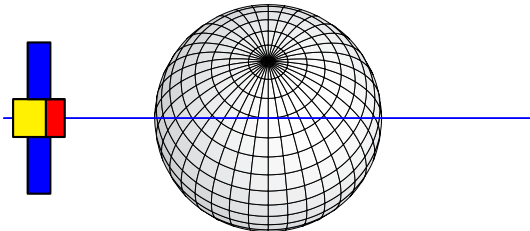

# Observing the satellite from the Sun

---

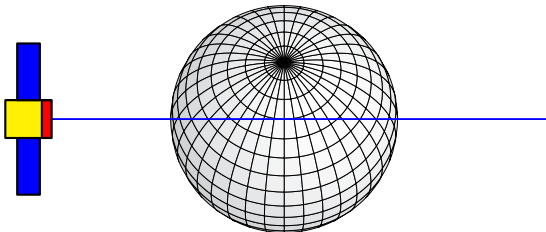

# Observing the satellite from the Sun

---

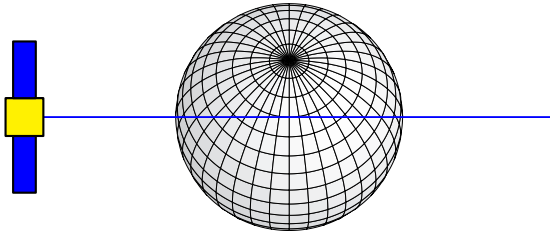

# Observing the satellite from the Sun

---

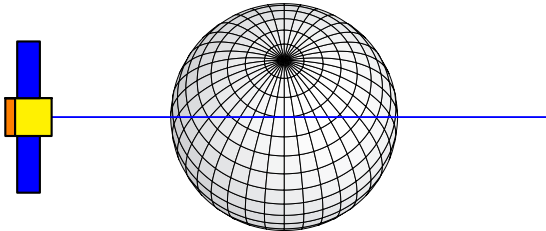



# Observing the satellite from the Sun

---

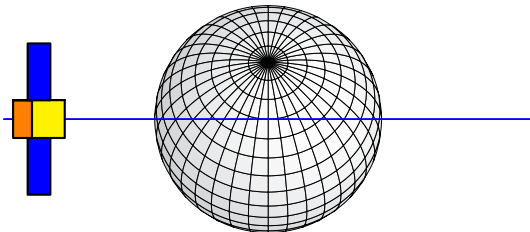

# Observing the satellite from the Sun

---

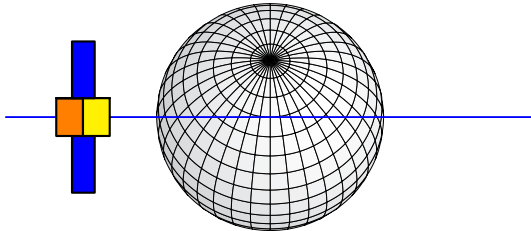

# Observing the satellite from the Sun

---

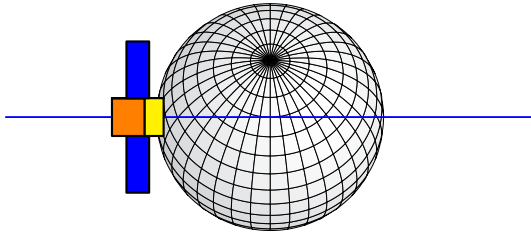

# Observing the satellite from the Sun

---

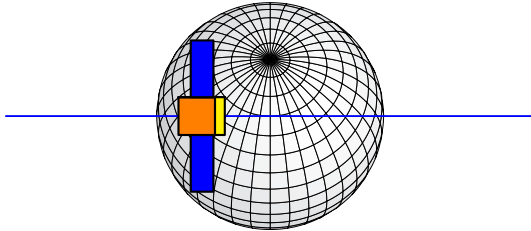

# Observing the satellite from the Sun

---

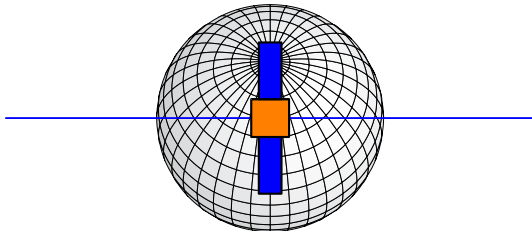

# Observing the satellite from the Sun

---

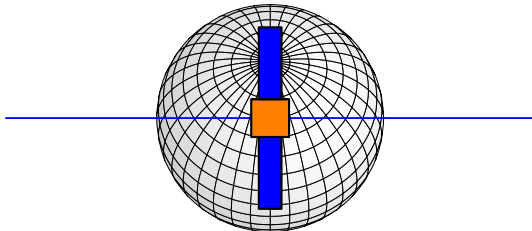

# Observing the satellite from the Sun

---

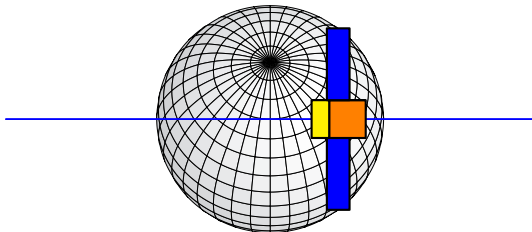

# Observing the satellite from the Sun

---

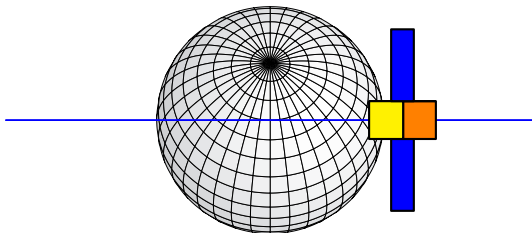



# Observing the satellite from the Sun

---

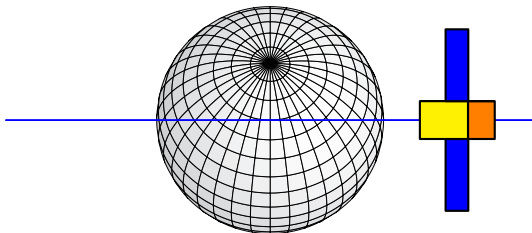

# Observing the satellite from the Sun

---

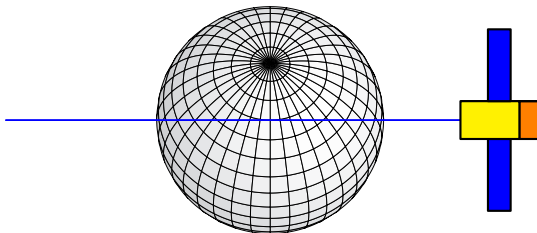

# Observing the satellite from the Sun

---

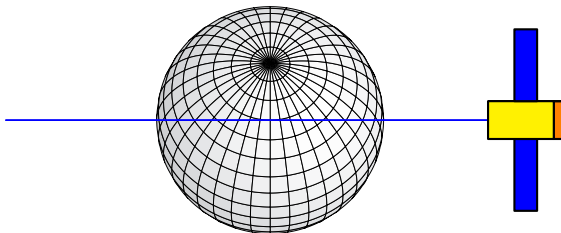

# Observing the satellite from the Sun

---

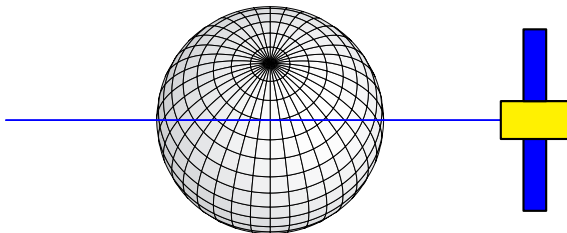

# Observing the satellite from the Sun

---

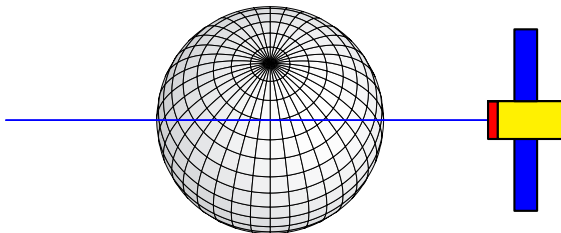

# Observing the satellite from the Sun

---

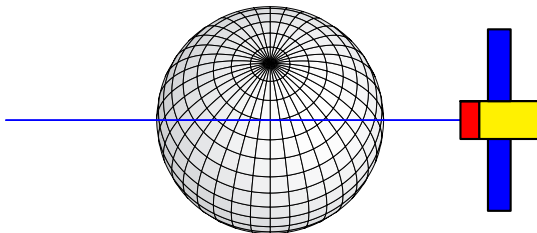

# Observing the satellite from the Sun

---

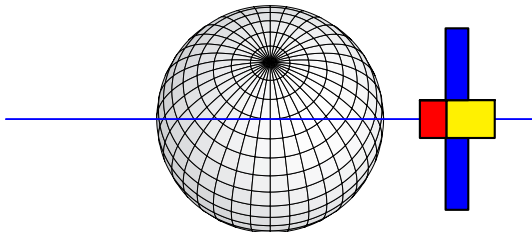

# Observing the satellite from the Sun

---

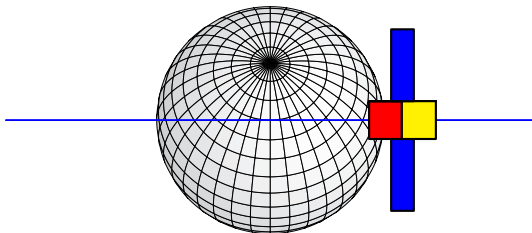



# Observing the satellite from the Sun

---

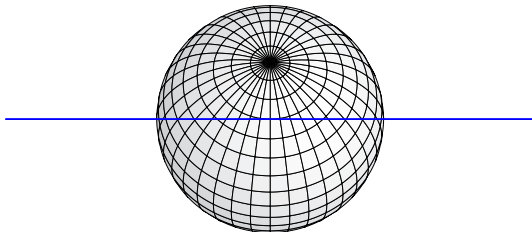

# Observing the satellite from the Sun

---

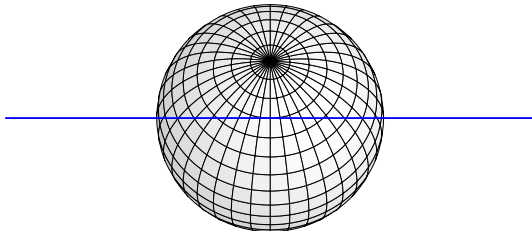

# Observing the satellite from the Sun

---

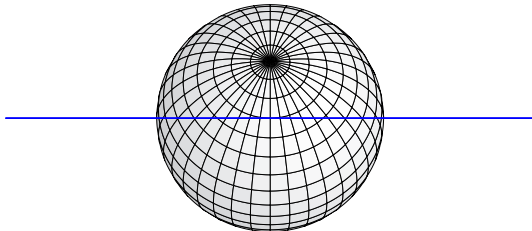

# Observing the satellite from the Sun

---

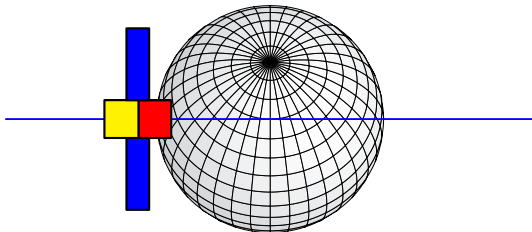

# Observing the satellite from the Sun

---

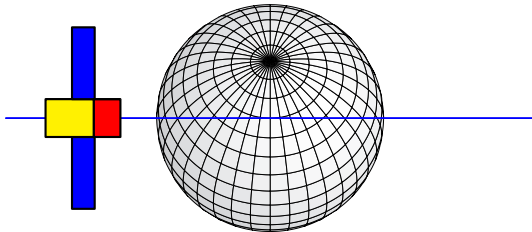

# Observing the satellite from the Sun

---

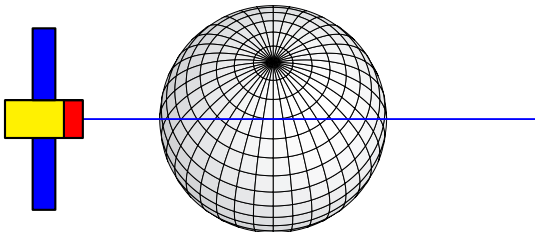

# Observing the satellite from the Sun

---

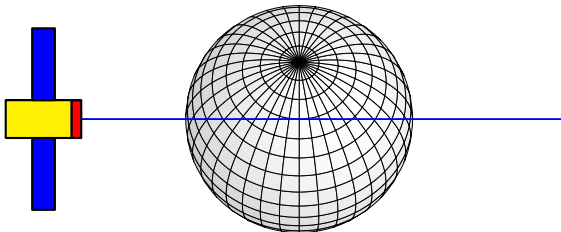

# Observing the satellite from the Sun

---

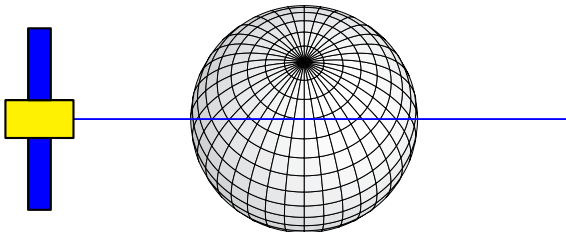



# Observing the satellite from the Sun

---

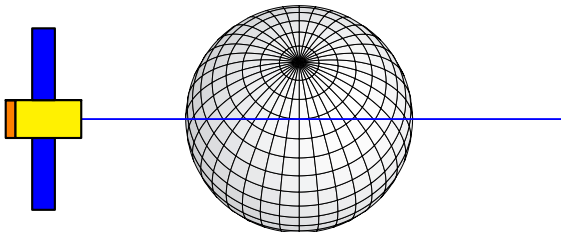

# Observing the satellite from the Sun

---

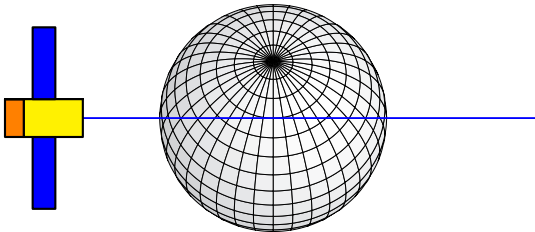

# Observing the satellite from the Sun

---

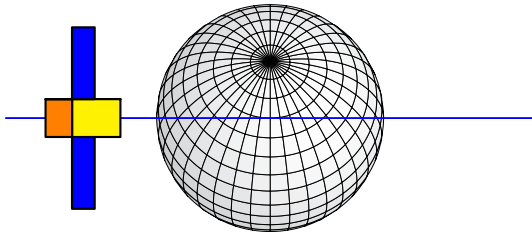

# Observing the satellite from the Sun

---

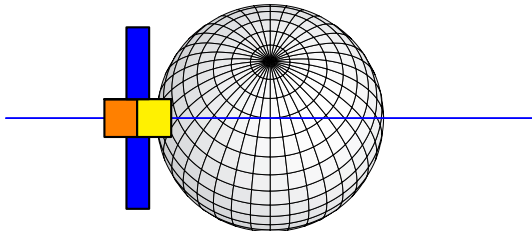

# Observing the satellite from the Sun

---

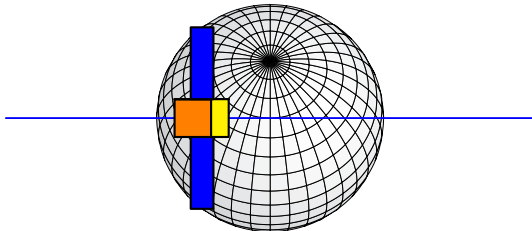

# Observing the satellite from the Sun

---

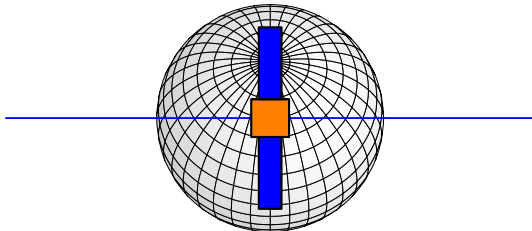

# The Empirical CODE Orbit Model

---

## Conclusions

- A Sun-fixed argument for the periodic terms is helpful to obtain interpretable series of these parameters:

$$\Delta u = u_{sat} - u_{Sun}$$

# The Empirical CODE Orbit Model

---

## Conclusions

- A Sun–fixed argument for the periodic terms is helpful to obtain interpretable series of these parameters:

$$\Delta u = u_{sat} - u_{Sun}$$

- Solar radiation pressure for satellites flying according to the previously mentioned models can be represented by:

$$D = D_0 + D_2 \cos(2\Delta u) + D_4 \cos(4\Delta u) + \dots$$

$$Y = Y_0$$

$$B = B_1 \cos(1\Delta u) + B_3 \cos(3\Delta u) + \dots$$

$Y_0 \neq 0$  if the satellite is flying “misaligned” with a  $Y$ –bias (e.g., GPS, except for Block IIF).



# Estimated Solar Radiation Pressure

Component:  $D_0$

GPS Block IIA

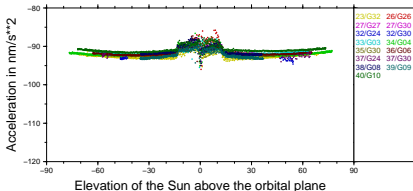

GPS Block IIR

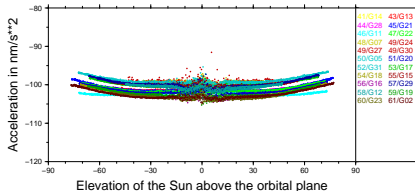

GPS Block IIF

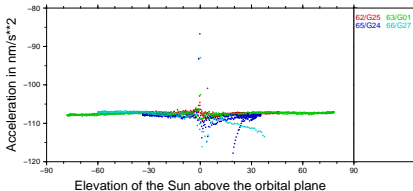

GLONASS-M

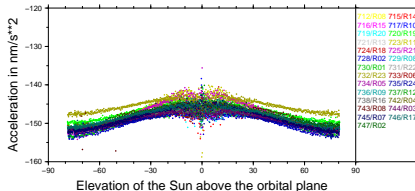

# Estimated Solar Radiation Pressure

## Component: $Y_0$ (small scale)

GPS Block IIA

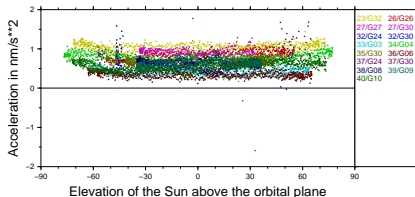

GPS Block IIR

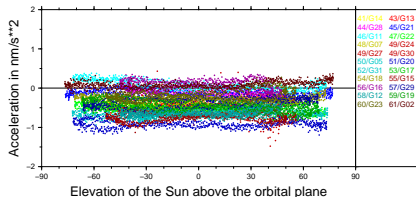

GPS Block IIF

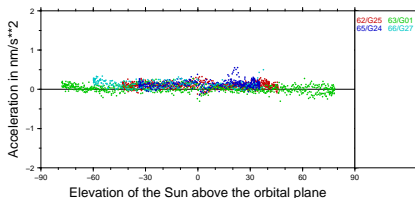

GLONASS-M

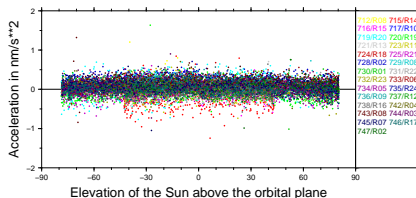

# Estimated Solar Radiation Pressure

Component:  $B_1 \cdot \cos(1\Delta u)$

GPS Block IIA

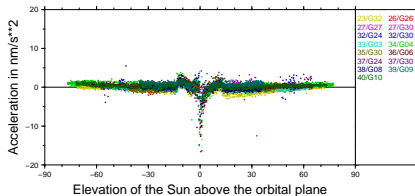

GPS Block IIR

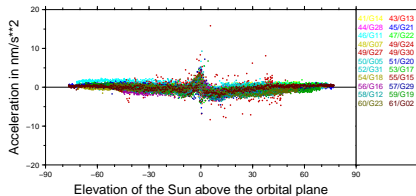

GPS Block IIF

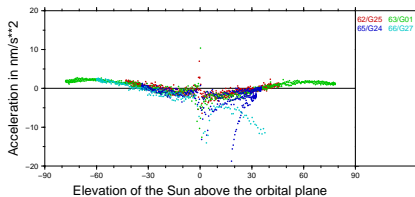

GLONASS-M

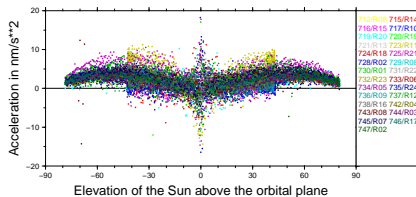

# Estimated Solar Radiation Pressure

Component:  $D_2 \cdot \cos(2\Delta u)$

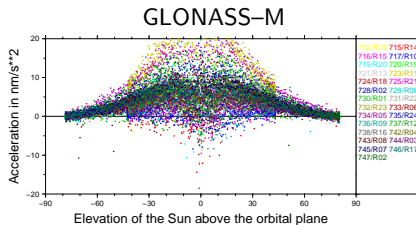
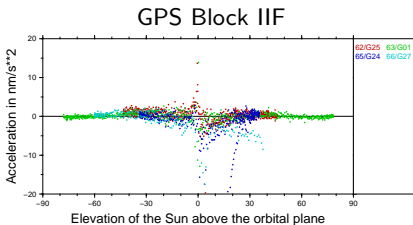
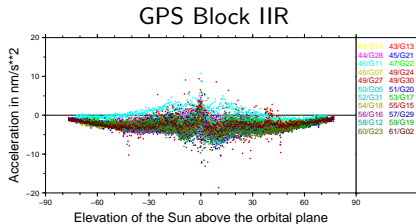
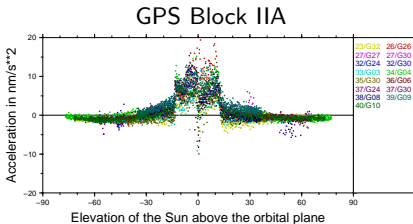

# Estimated Solar Radiation Pressure

Component:  $B_1 \cdot \sin(1\Delta u)$

GPS Block IIA

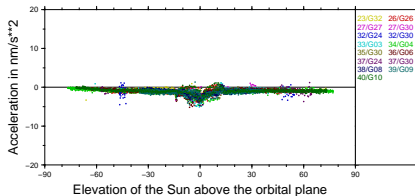

GPS Block IIR

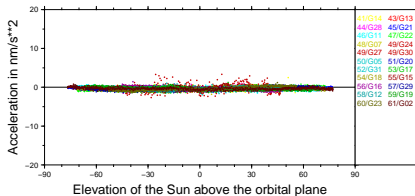

GPS Block IIF

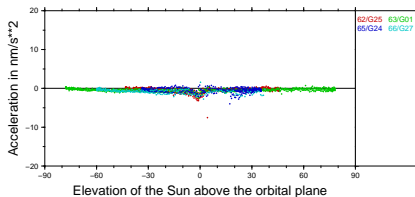

GLONASS-M

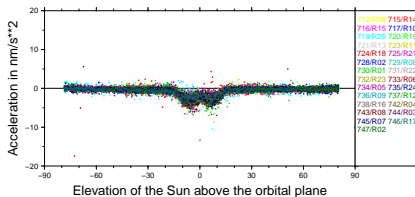

# Estimated Solar Radiation Pressure

Component:  $D_2 \cdot \sin(2\Delta u)$

GPS Block IIA

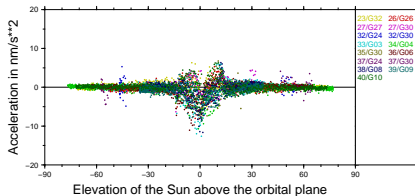

GPS Block IIR

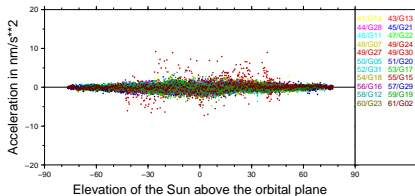

GPS Block IIF

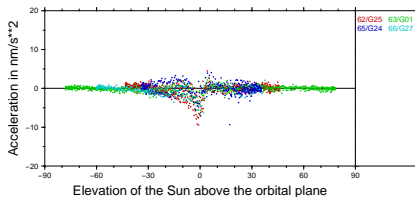

GLONASS-M

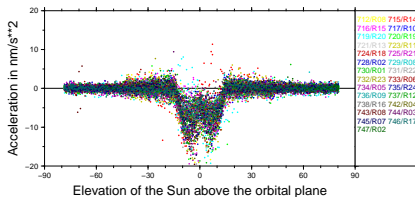

# Estimated Solar Radiation Pressure

---

## Conclusions

- The definition of the angular argument ( $\Delta u = u_{sat} - u_{Sun}$  instead of  $u_{sat}$ ) allows a better interpretation of estimated parameter series, e.g., w.r.t. the elevation of the Sun above the orbital plane.

# Estimated Solar Radiation Pressure

---

## Conclusions

- The definition of the angular argument ( $\Delta u = u_{sat} - u_{Sun}$  instead of  $u_{sat}$ ) allows a better interpretation of estimated parameter series, e.g., w.r.t. the elevation of the Sun above the orbital plane.
- Adding twice-per-revolution terms in  $D$ -component improves the orbit solution, in particular for satellites with stretched bodies.



# Estimated Solar Radiation Pressure

---

## Conclusions

- The definition of the angular argument ( $\Delta u = u_{sat} - u_{Sun}$  instead of  $u_{sat}$ ) allows a better interpretation of estimated parameter series, e.g., w.r.t. the elevation of the Sun above the orbital plane.
- Adding twice-per-revolution terms in  $D$ -component improves the orbit solution, in particular for satellites with stretched bodies.
- Even if the sin-terms are not necessary according to theory they are needed for representing real satellite trajectories.

# The Empirical CODE Orbit Model

---

$$D = D_0 + \sum_{i=1}^{n_D} D_{2i,c} \cos(2i \cdot \Delta u) + D_{2i,s} \sin(2i \cdot \Delta u) \quad (4)$$

$$Y = Y_0$$

$$B = B_0 + \sum_{i=1}^{n_B} B_{2i-1,c} \cos((2i-1) \cdot \Delta u) + B_{2i-1,s} \sin((2i-1) \cdot \Delta u)$$

- In practice the expansion is only used up to  $n_D = n_B = 1$ .

# The Empirical CODE Orbit Model

---

- The **empirical CODE Orbit Mode (ECOM)** as shown in Equation 4 on slide 65 was developed in [Arnold et al., 2015](#).
- The extension considers in particular the effect on satellites with **stretched bodies** (e.g., GLONASS, Galileo, QZSS).

# The Empirical CODE Orbit Model

---

- The **empirical CODE Orbit Mode (ECOM)** as shown in Equation 4 on slide 65 was developed in [Arnold et al., 2015](#).
- The extension considers in particular the effect on satellites with **stretched bodies** (e.g., GLONASS, Galileo, QZSS).
- It is an **extension** of the classical ECOM as introduced by [Beutler et al., 1994](#). ( $n_D = 0$  and  $n_B = 1$ )

# The Empirical CODE Orbit Model

---

- The **empirical CODE Orbit Mode (ECOM)** as shown in Equation 4 on slide 65 was developed in [Arnold et al., 2015](#).
- The extension considers in particular the effect on satellites with **stretched bodies** (e.g., GLONASS, Galileo, QZSS).
- It is an **extension** of the classical ECOM as introduced by [Beutler et al., 1994](#). ( $n_D = 0$  and  $n_B = 1$ )
- The ECOM is widely used within the IGS.

In the semi-analytical approach the ECOM is also often in use to compensate for the deficiencies of the introduced a priori models.

# Shadow Effects

---

- If the elevation of the Sun  $\beta$  becomes smaller than a certain angle  $\beta_0$ , so called **eclipse phases** occur where the satellite is **not illuminated by the Sun**.

During eclipse, the force caused by the solar radiation needs to be switched off in the orbit model during the eclipse phase.

# Shadow Effects

---

- If the elevation of the Sun  $\beta$  becomes smaller than a certain angle  $\beta_0$ , so called **eclipse phases** occur where the satellite is **not illuminated by the Sun**.

During eclipse, the force caused by the solar radiation needs to be switched off in the orbit model during the eclipse phase.

- The limit  $\beta_0$  is computed by  $\beta_0 = \arcsin \frac{a_{Earth}}{a_{sat}}$   
(with  $a_{Earth} = 6\,380$  km):

GLONASS	$a = 25\,500$ km	$\beta_0 = 14.5^\circ$
GPS	$a = 26\,560$ km	$\beta_0 = 13.9^\circ$
Galileo	$a = 30\,000$ km	$\beta_0 = 12.3^\circ$
QZSS	$a = 42\,000$ km	$\beta_0 = 8.7^\circ$

# Shadow Effects

---

- If the elevation of the Sun  $\beta$  becomes smaller than a certain angle  $\beta_0$ , so called **eclipse phases** occur where the satellite is **not illuminated by the Sun**.

During eclipse, the force caused by the solar radiation needs to be switched off in the orbit model during the eclipse phase.

- The limit  $\beta_0$  is computed by  $\beta_0 = \arcsin \frac{a_{Earth}}{a_{sat}}$   
(with  $a_{Earth} = 6\,380$  km):

GLONASS	$a = 25\,500$ km	$\beta_0 = 14.5^\circ$
GPS	$a = 26\,560$ km	$\beta_0 = 13.9^\circ$
Galileo	$a = 30\,000$ km	$\beta_0 = 12.3^\circ$
QZSS	$a = 42\,000$ km	$\beta_0 = 8.7^\circ$

- The period where the satellite crosses the shadow of the Earth takes about **one hour** for a **GNSS satellite** in a **MEO orbit**.



# Shadow Effects

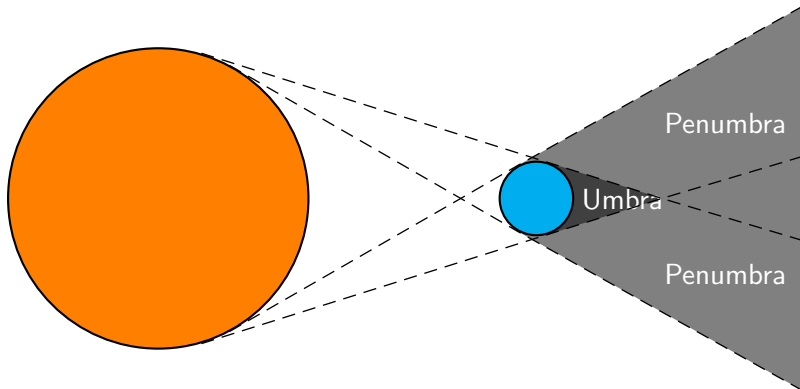

# Shadow Effects

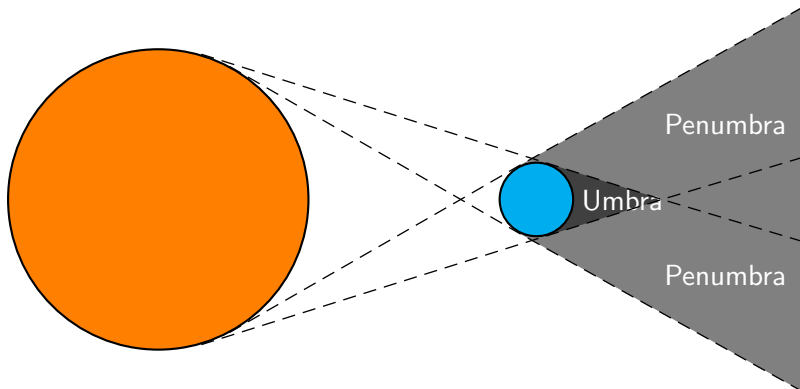

- A satellite flying into the shadow area behind the Earth crosses the penumbra in such a short interval that it can be neglected.

# Shadow Effects

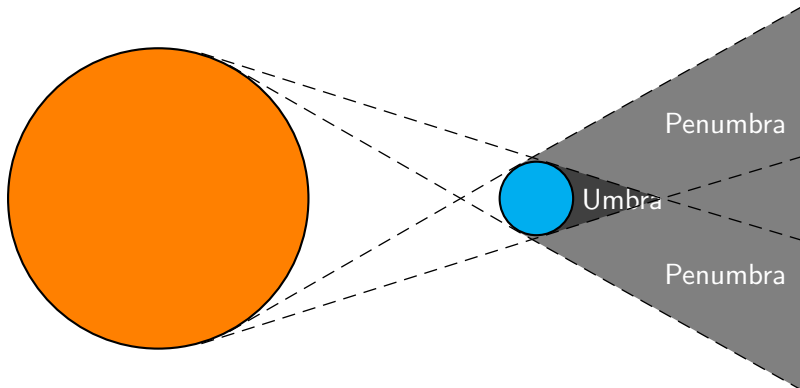

- A satellite flying into the shadow area behind the Earth crosses the penumbra in such a short interval that it can be neglected.
- The penumbra is on the other hand essential for the shadow generated by the Moon.

# Other Radiation Pressure Effects

---

The biggest contribution comes from the

- **solar (or direct) radiation pressure**

GPS:  $\approx 250$  m

Galileo:  $\approx 350$  m

QZSS:  $\approx 700$  m

Maximal influence of the effect on the orbit after one day of orbit integration.

# Other Radiation Pressure Effects

---

The biggest contribution comes from the

- **solar (or direct) radiation pressure**

GPS:  $\approx 250$  m

Galileo:  $\approx 350$  m

QZSS:  $\approx 700$  m

Indirect radiation pressure effects due to solar radiation are

- **reflected/re-emitted by the Earth (Albedo effect)**

GPS:  $\approx 1$  m

Galileo:  $\approx ??$  m

QZSS:  $\approx ??$  m

Maximal influence of the effect on the orbit after one day of orbit integration.

# Other Radiation Pressure Effects

---

The biggest contribution comes from the

- **solar (or direct) radiation pressure**

GPS:  $\approx 250$  m

Galileo:  $\approx 350$  m

QZSS:  $\approx 700$  m

Indirect radiation pressure effects due to solar radiation are

- **reflected/re-emitted by the Earth (Albedo effect)**

GPS:  $\approx 1$  m

Galileo:  $\approx ??$  m

QZSS:  $\approx ??$  m

- **reflected/re-emitted by the Moon**  
currently neglected for GNSS satellites

Maximal influence of the effect on the orbit after one day of orbit integration.

# Equation of Motion

---

In order to consider the **gravitational** and **non-gravitational** perturbations described before we have to extend the initial version of the equation of motion, see eqn. (3), by a function  $f$ :

$$\ddot{\vec{r}} = -GM_E \frac{\vec{r}}{|\vec{r}|^3} + f(t, \vec{r}, \dot{\vec{r}}, Q_1, \dots, Q_n),$$

with initial conditions

$$\vec{r}(t_0) = \vec{r}(a, e, i, \Omega, \omega, u_0; t_0) \quad \text{and}$$

$$\dot{\vec{r}}(t_0) = \dot{\vec{r}}(a, e, i, \Omega, \omega, u_0; t_0),$$

as well as  $Q_1, \dots, Q_n$  shall represent all known and unknown parameters of the force model (e.g., for the Earth's gravity field or the solar radiation pressure).

# Osculating Elements

The perturbations described by the function  $f$  cause a permanent change of the orbital elements, the so call osculating elements:

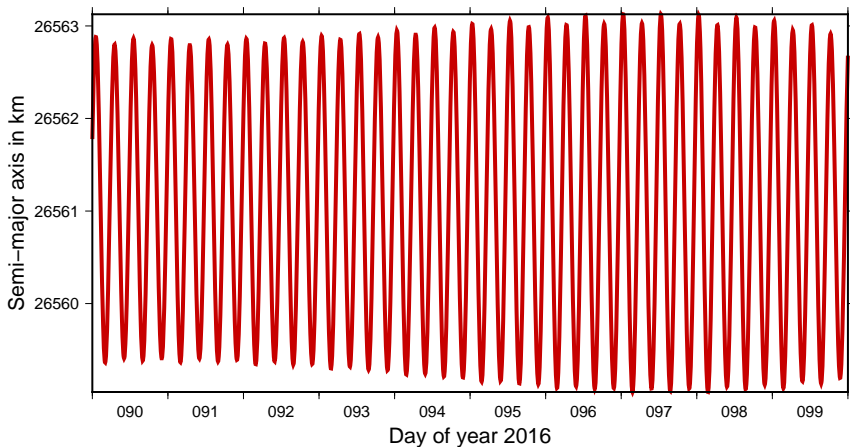

GPS satellite G12.



# Osculating Elements

The perturbations described by the function  $f$  cause a permanent change of the orbital elements, the so call osculating elements:

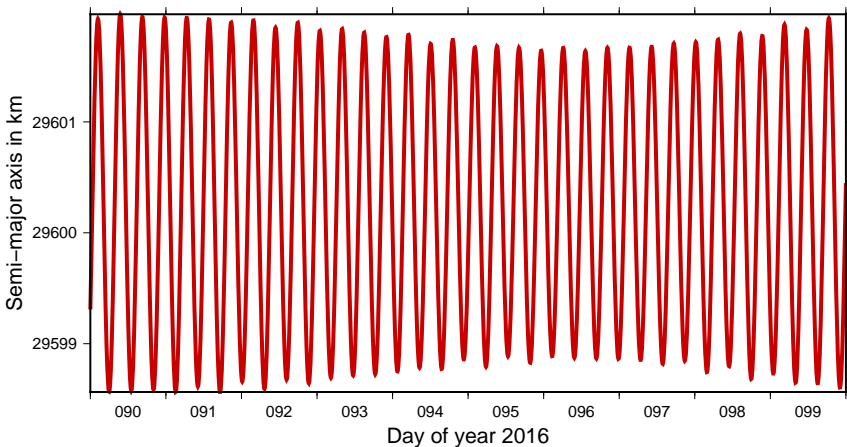

Galileo satellite E12.

# Osculating Elements

The perturbations described by the function  $f$  cause a permanent change of the orbital elements, the so call osculating elements:

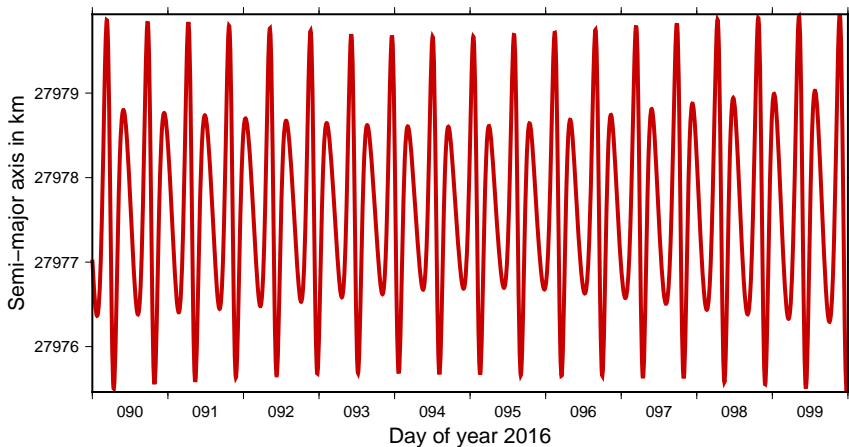

Galileo satellite E14.

# Osculating Elements

The perturbations described by the function  $f$  cause a permanent change of the orbital elements, the so call osculating elements:

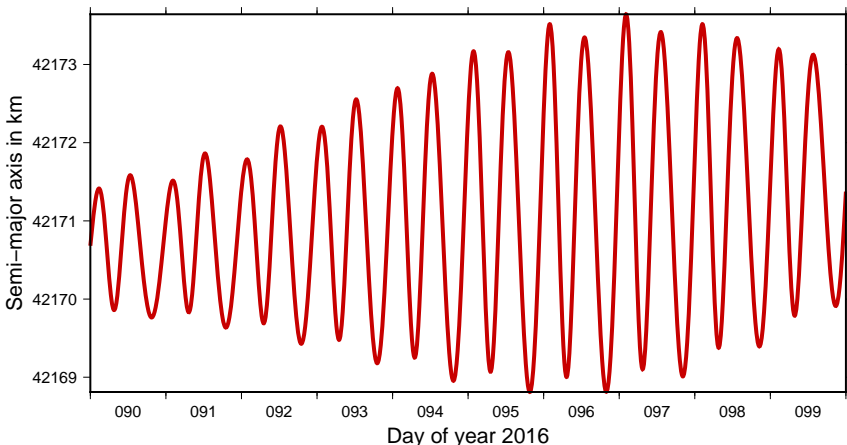

QZSS satellite J01.

# Precise Orbit Determination for GNSS Satellites

---

Introduction and Motivation

Overview on the GNSS Constellations

Effects Acting on Satellites and Related Models

Precise Orbit Determination for GNSS Satellites

Precise Orbit Determination in Practise

Methods of GNSS-Orbit Validation

GNSS Orbit Determination within the IGS

# GNSS Satellites in CODE Solution

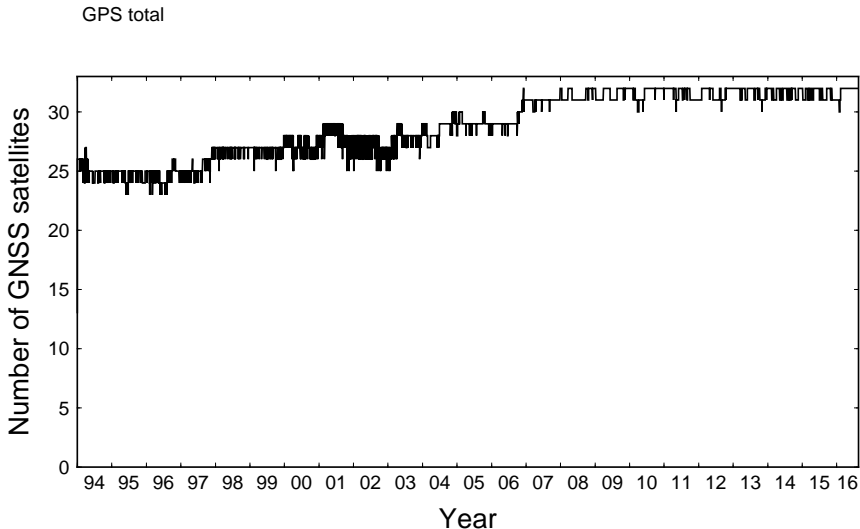

Development of the GPS satellite constellation

# GNSS Satellites in CODE Solution

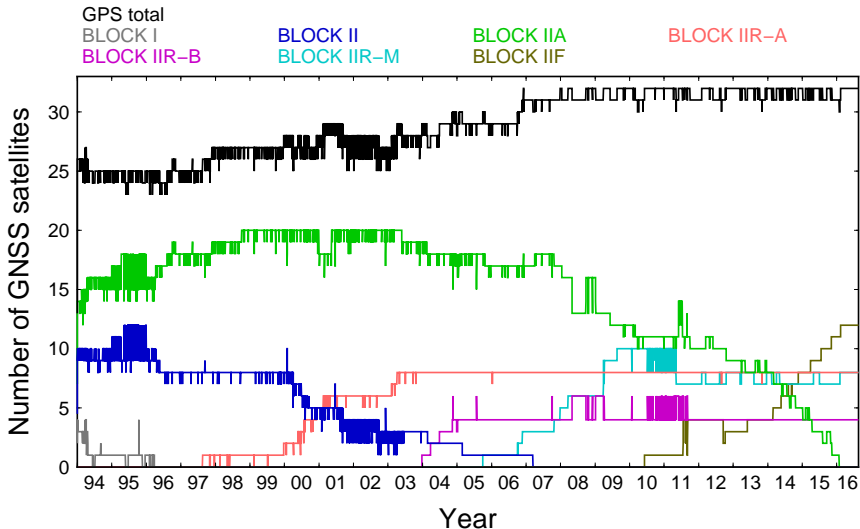

Development of the GPS satellite constellation

# GNSS Satellites in CODE Solution

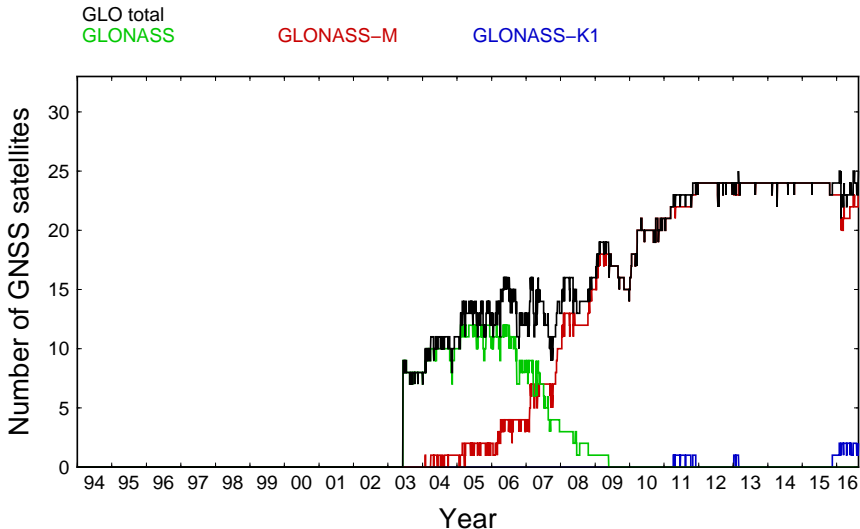

Development of the GLONASS satellite constellation

# GNSS Stations in CODE Solution

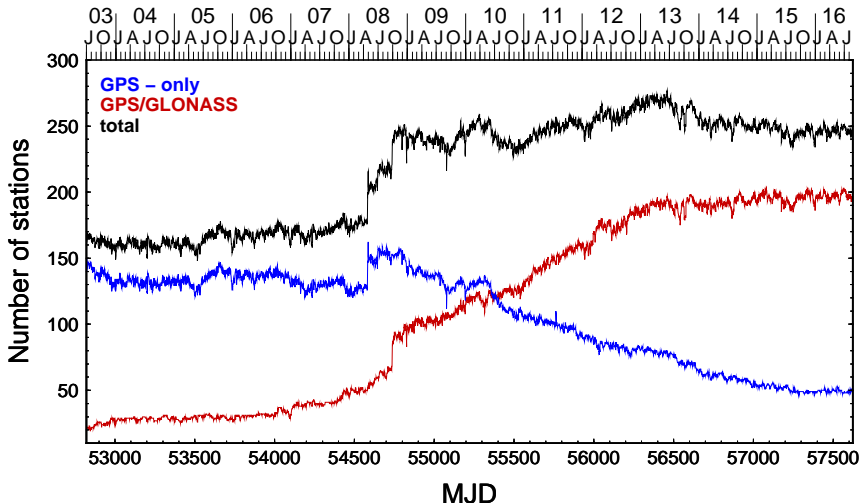

Development of the number of GLONASS tracking stations



# GNSS Stations in CODE Solution

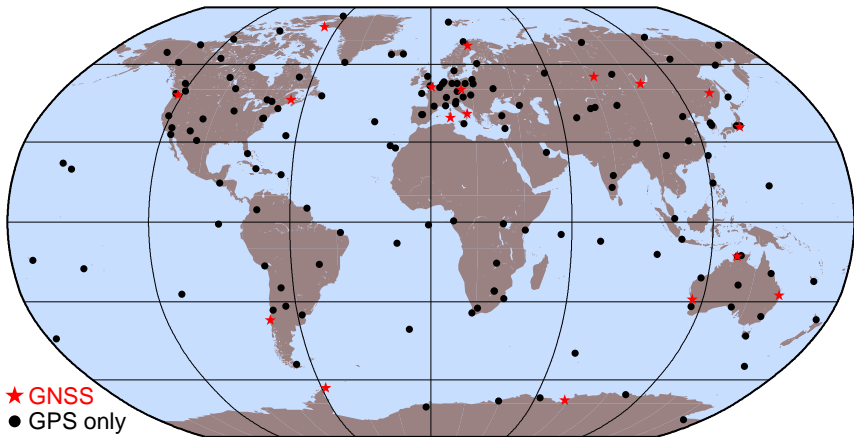

Network used for the GNSS processing at CODE.

Status: June 2003

# GNSS Stations in CODE Solution

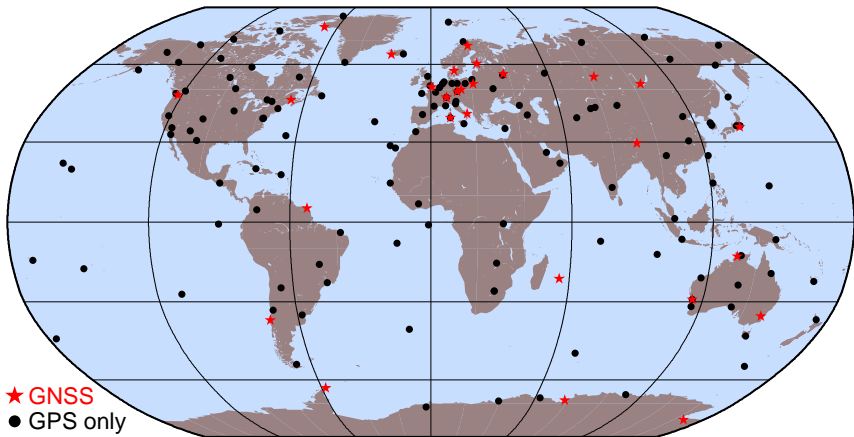

Network used for the GNSS processing at CODE.

Status: June 2004

# GNSS Stations in CODE Solution

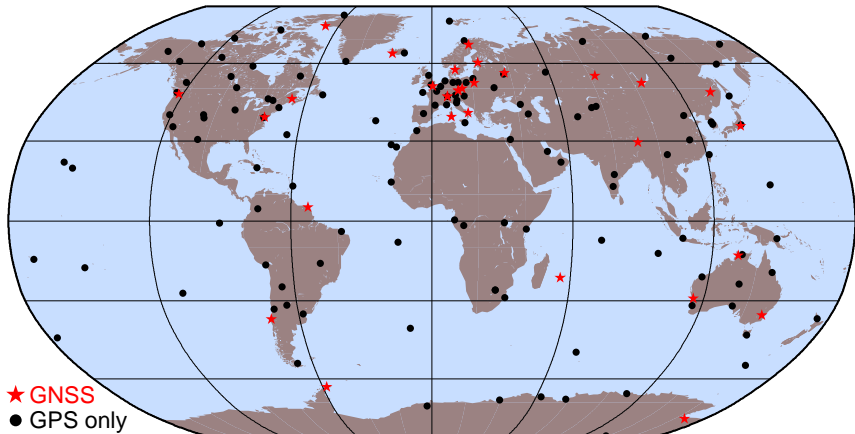

Network used for the GNSS processing at CODE.

Status: June 2005

# GNSS Stations in CODE Solution

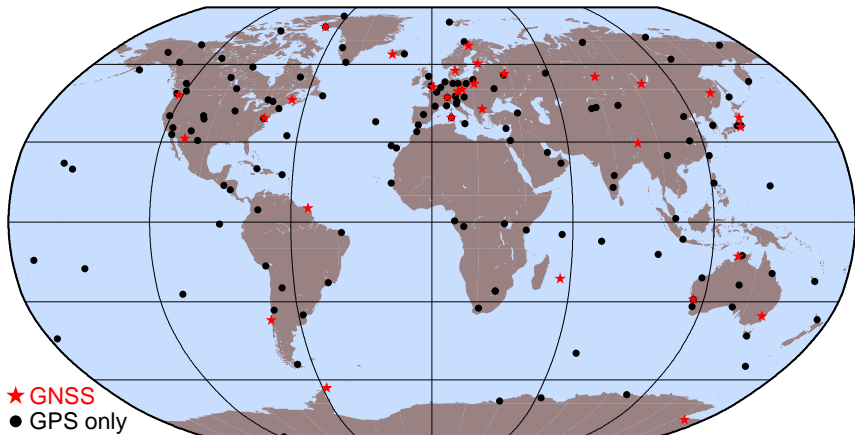

Network used for the GNSS processing at CODE.

Status: June 2006

# GNSS Stations in CODE Solution

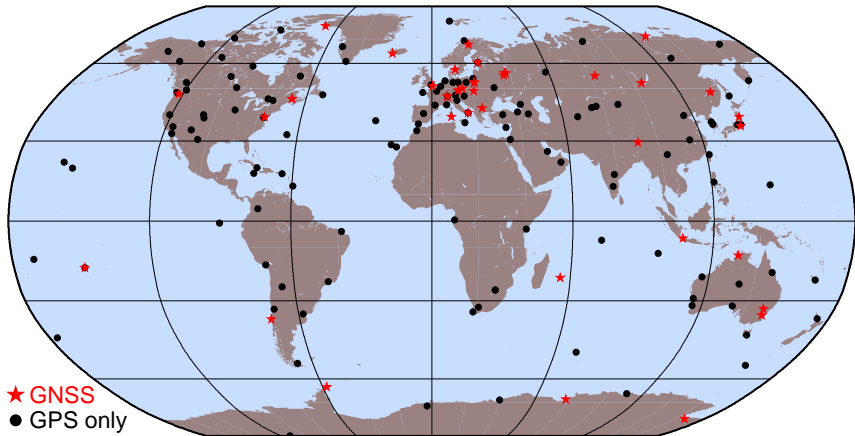

Network used for the GNSS processing at CODE.

Status: June 2007

# GNSS Stations in CODE Solution

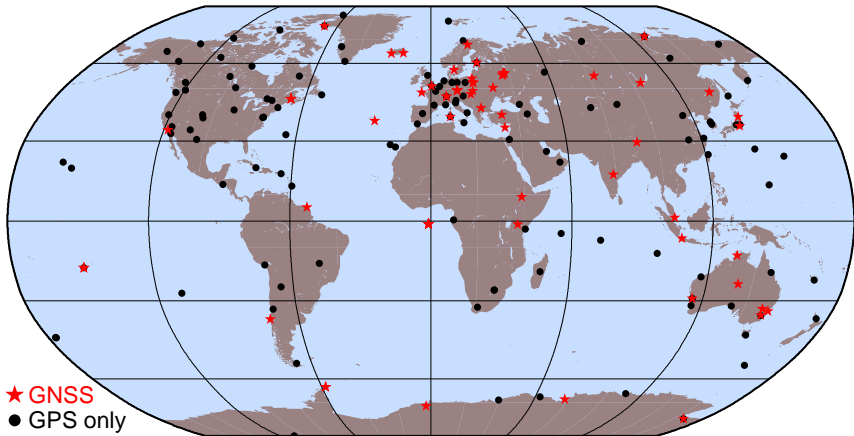

Network used for the GNSS processing at CODE.

Status: June 2008

# GNSS Stations in CODE Solution

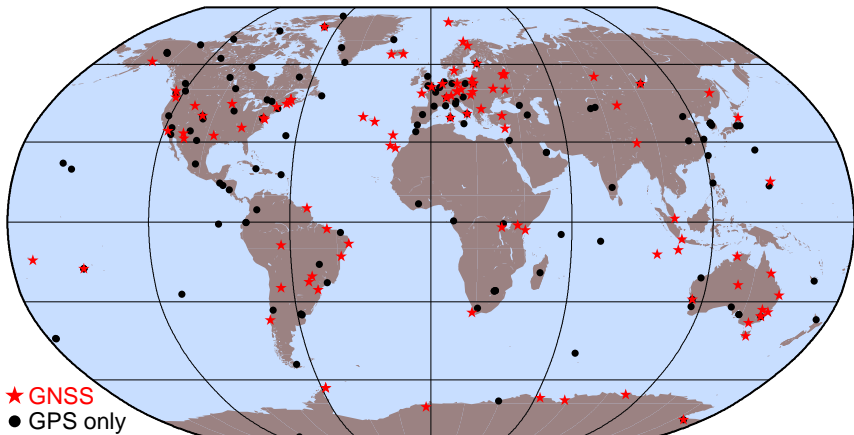

Network used for the GNSS processing at CODE.

Status: June 2009

# GNSS Stations in CODE Solution

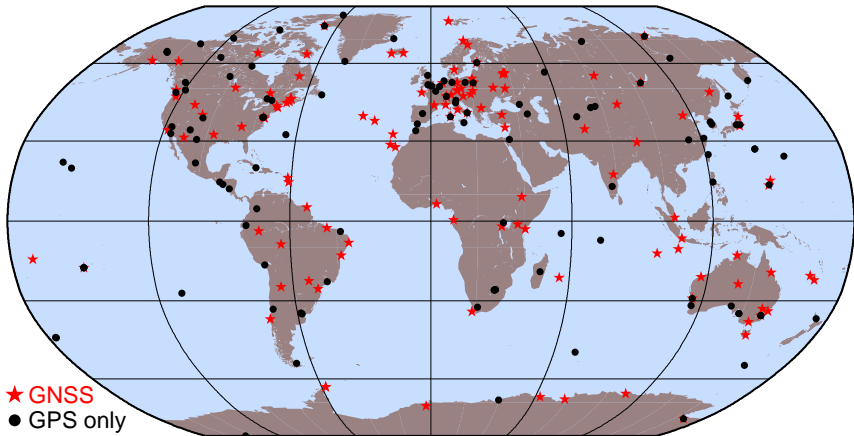

Network used for the GNSS processing at CODE.

Status: June 2010



# GNSS Stations in CODE Solution

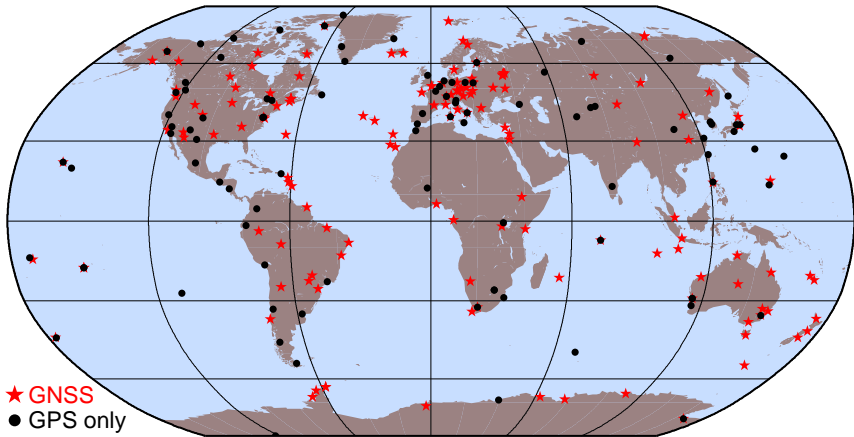

Network used for the GNSS processing at CODE.

Status: June 2011

# GNSS Stations in CODE Solution

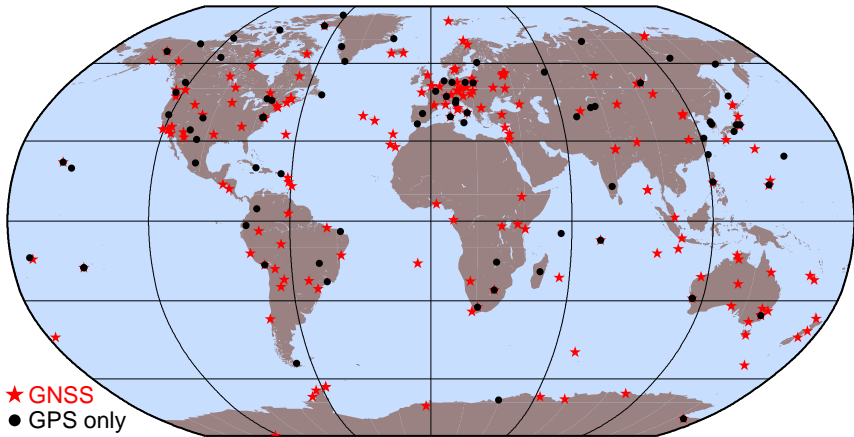

Network used for the GNSS processing at CODE.

Status: June 2012

# GNSS Stations in CODE Solution

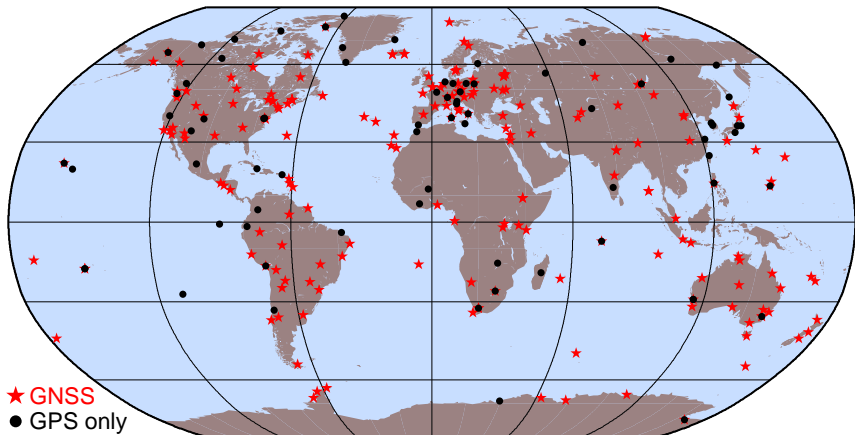

Network used for the GNSS processing at CODE.

Status: June 2013

# GNSS Stations in CODE Solution

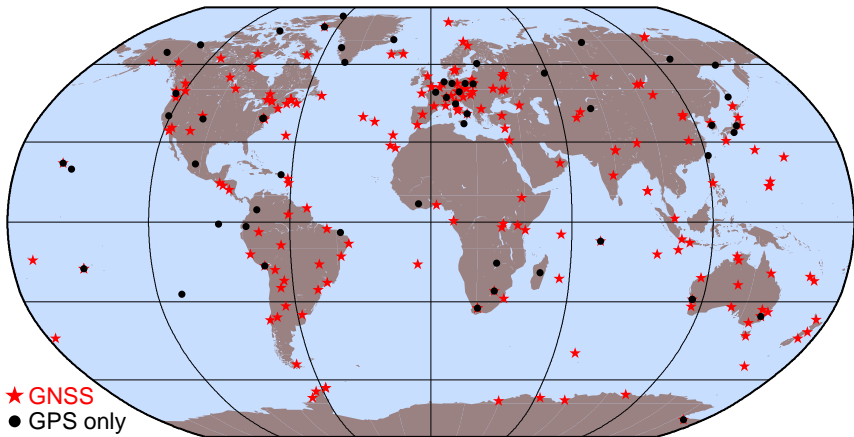

Network used for the GNSS processing at CODE.

Status: June 2014

# GNSS Stations in CODE Solution

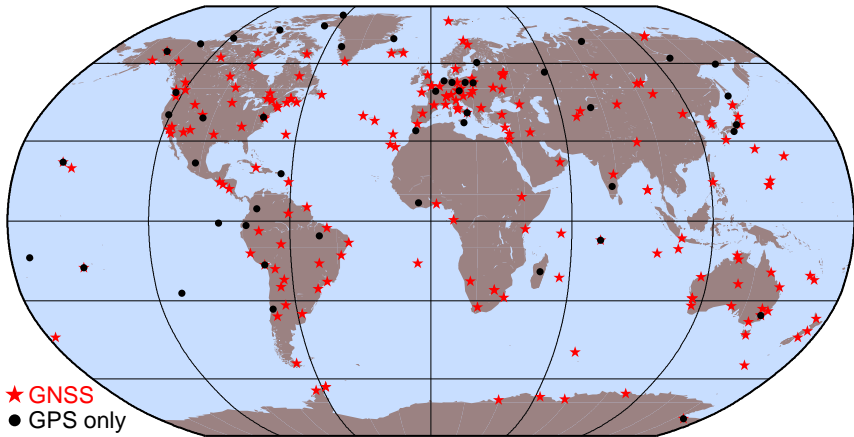

Network used for the GNSS processing at CODE.

Status: June 2015

# GNSS Stations in CODE Solution

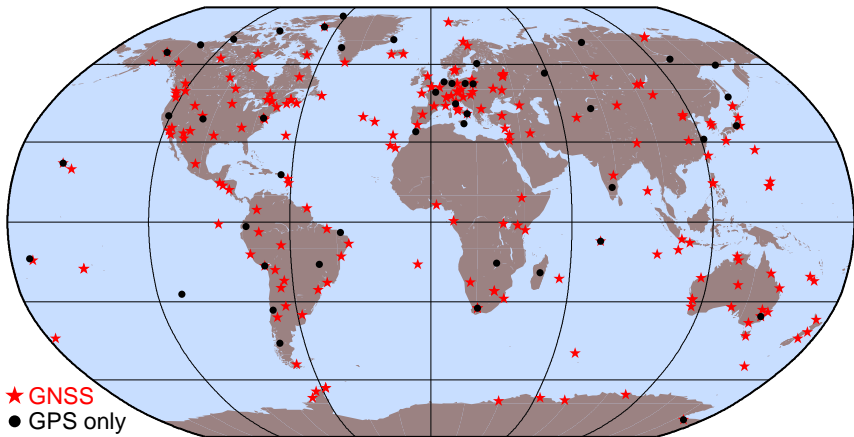

Network used for the GNSS processing at CODE.

Status: June 2016

# CODE GNSS Satellite Orbits

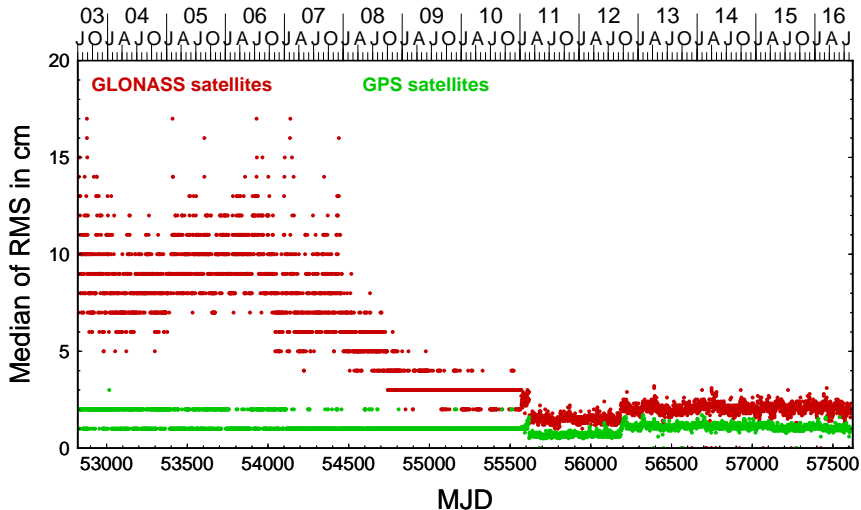

Development of the GLONASS orbit accuracy in the CODE final processing.

# CODE GNSS Satellite Orbits

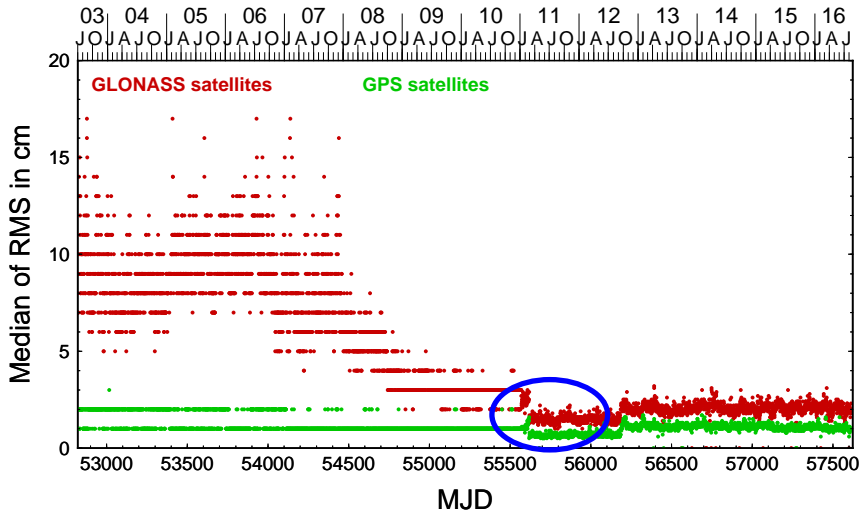

Development of the GLONASS orbit accuracy in the CODE final processing.



# CODE GNSS Satellite Orbits

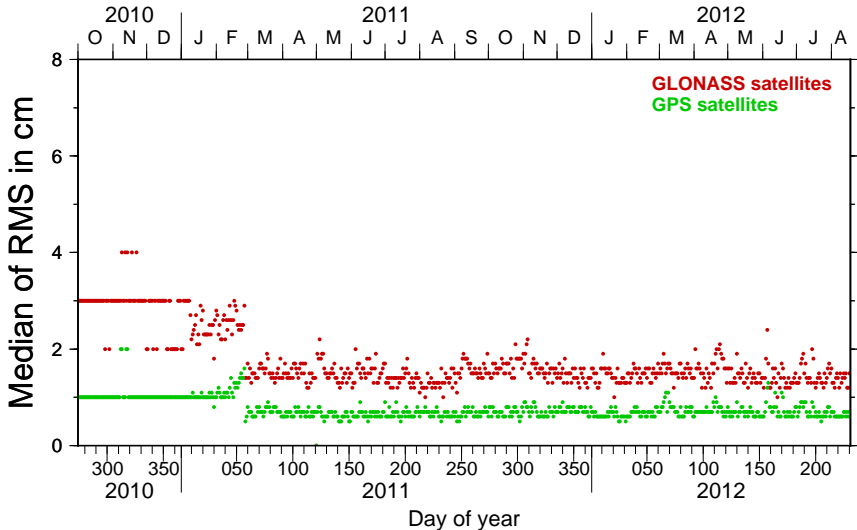

# CODE GNSS Satellite Orbits

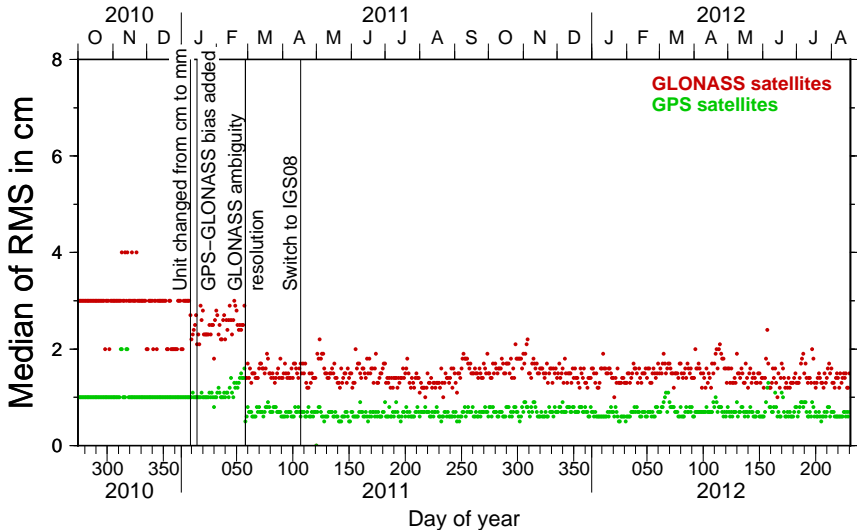

# CODE GNSS Satellite Orbits

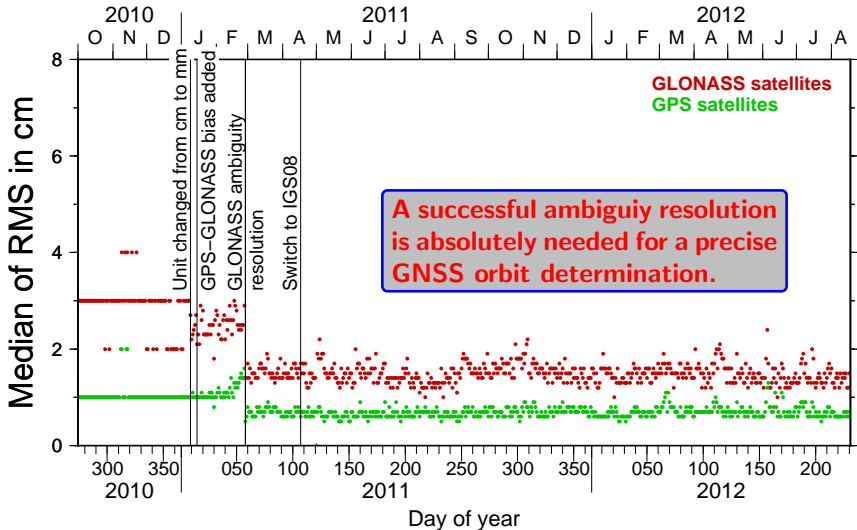

# Multi-Day Solutions

---

Orbit solution day  $n$



# Multi-Day Solutions

---



# Multi-Day Solutions

---

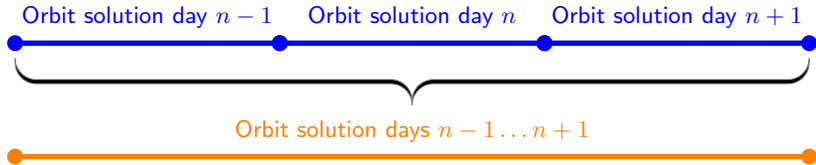

# Multi-Day Solutions

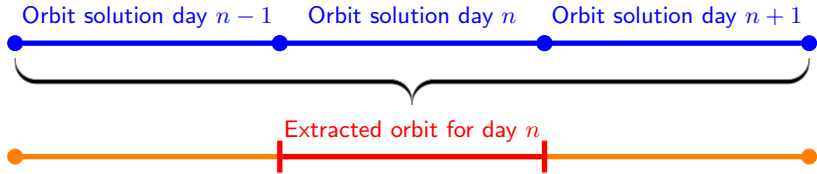

# Multi-Day Solutions

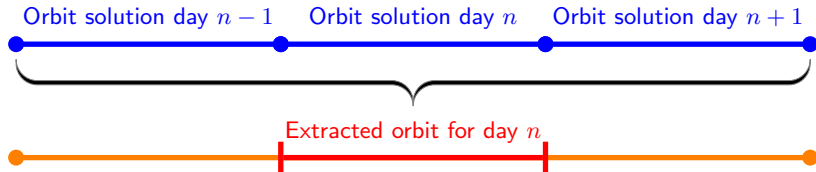

Advantage of the "Extracted orbit for day  $n$ " with respect to the direct "Orbit solution day  $n$ ":

- better decorrelation between orbit and Earth rotation parameters.
- no (or at least less) degradation of the orbit at the end of the boundary.
- smoothed day boundary discontinuities (in particular if the satellite was only weakly observed).



# Tracking Situation in the MGEX Network

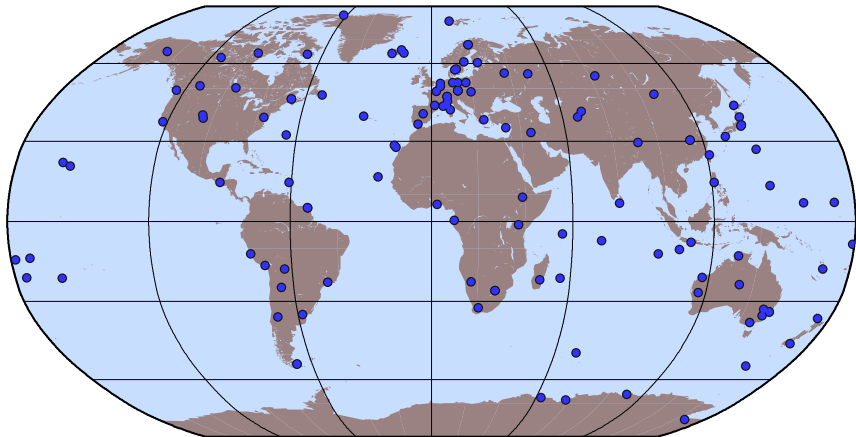

Network used for the CODE MGEX solution: [stations tracking GPS](#)

Status: July 2016.

# Tracking Situation in the MGEX Network

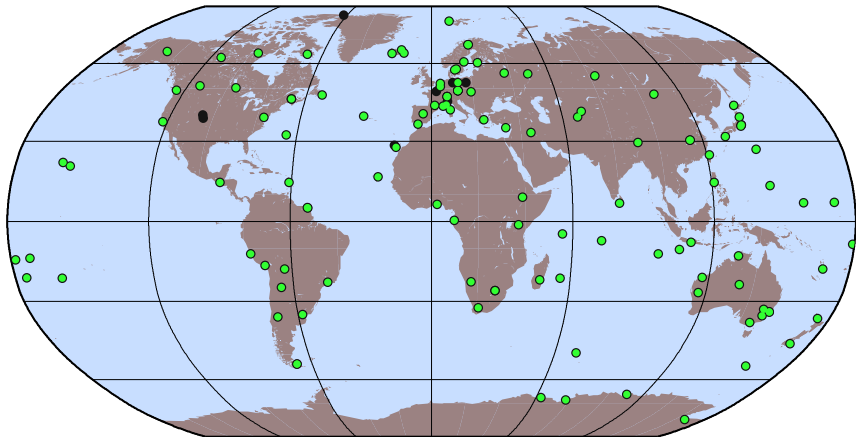

Network used for the CODE MGEX solution: stations tracking GLONASS

Status: July 2016.

# Tracking Situation in the MGEX Network

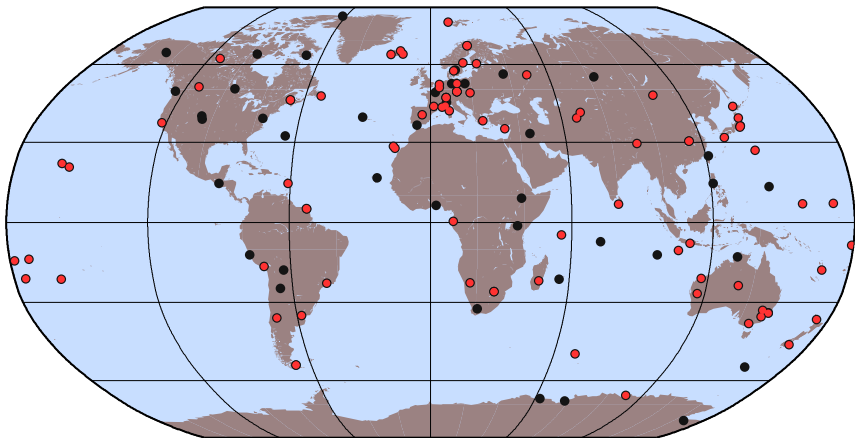

Network used for the CODE MGEX solution: stations tracking Galileo

Status: July 2016.

# Tracking Situation in the MGEX Network

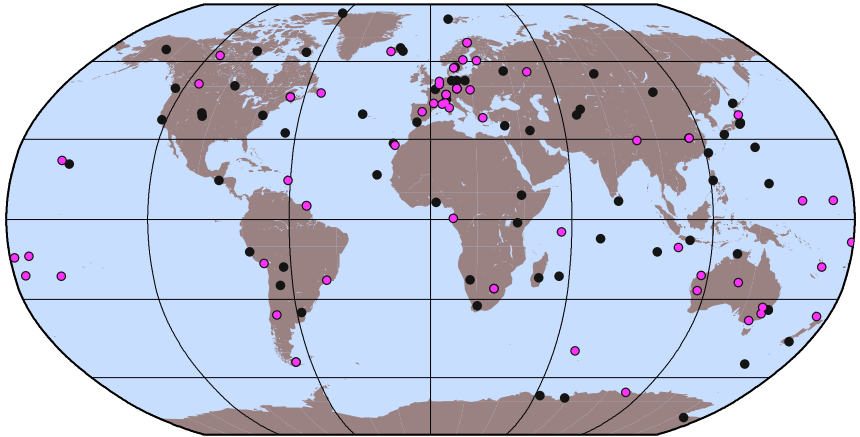

Network used for the CODE MGEX solution: stations tracking BeiDou

Status: July 2016.

# Tracking Situation in the MGEX Network

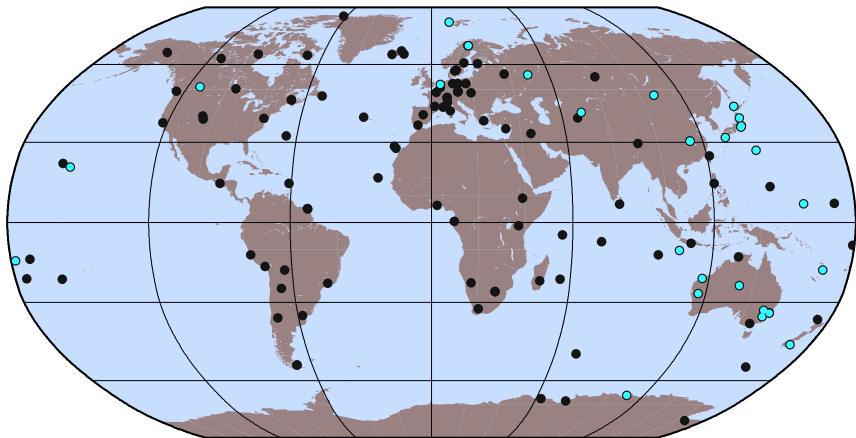

Network used for the CODE MGEX solution: [stations tracking QZSS](#)

Status: July 2016.

# Validation by Fitting Long Arcs

---

## 1. Fitting long arcs

Orbit solution day  $n - 1$

Orbit solution day  $n$

Orbit solution day  $n + 1$



# Validation by Fitting Long Arcs

---

## 1. Fitting long arcs

Orbit solution day  $n - 1$

Orbit solution day  $n$

Orbit solution day  $n + 1$



# Validation by Fitting Long Arcs

---

## 1. Fitting long arcs





# Validation by Fitting Long Arcs

---

## 1. Fitting long arcs

Orbit solution day  $n - 1$

Orbit solution day  $n$

Orbit solution day  $n + 1$

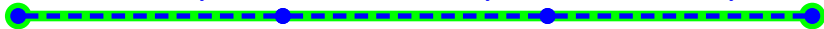

# Validation by Fitting Long Arcs

## CODE MGEX solution for the year 2015

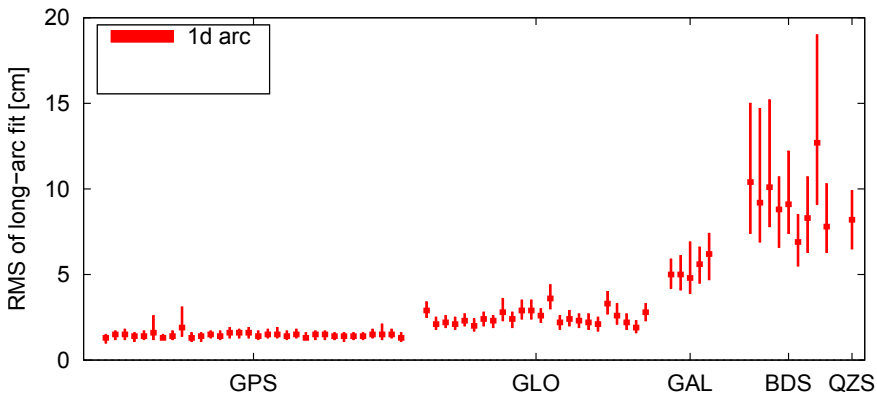

Median per satellite with associated quantiles

# Validation by Fitting Long Arcs

## CODE MGEX solution for the year 2015

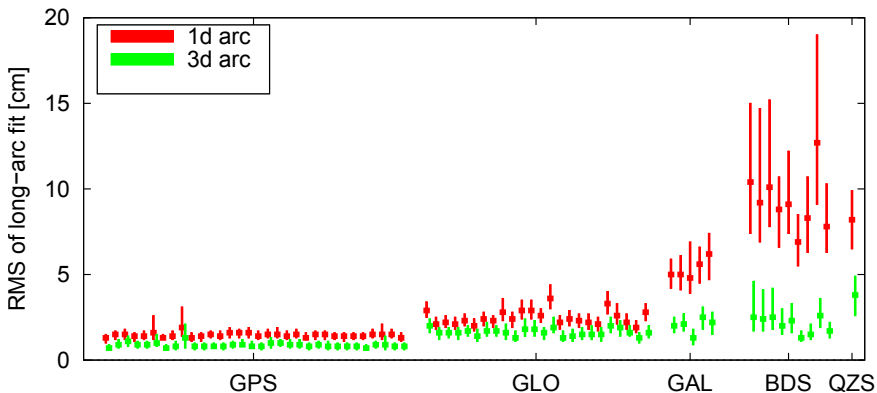

Median per satellite with associated quantiles

# Validation by Fitting Long Arcs

## CODE MGEX solution for the year 2015

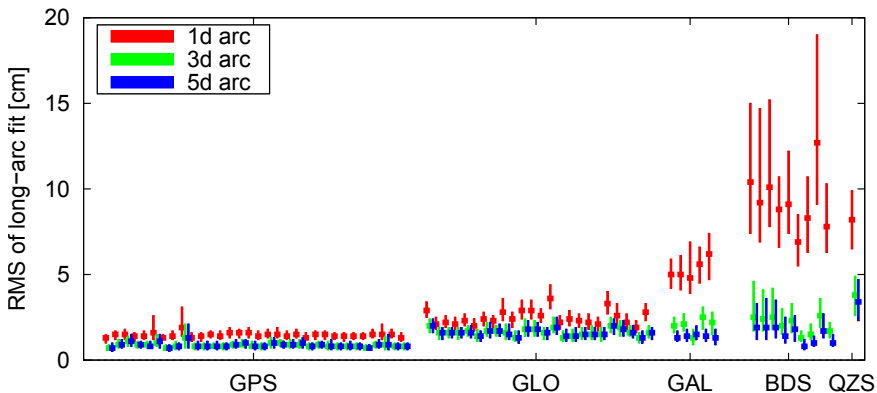

Median per satellite with associated quantiles

# Validation by Fitting Long Arcs

## CODE MGEX solution for the year 2015

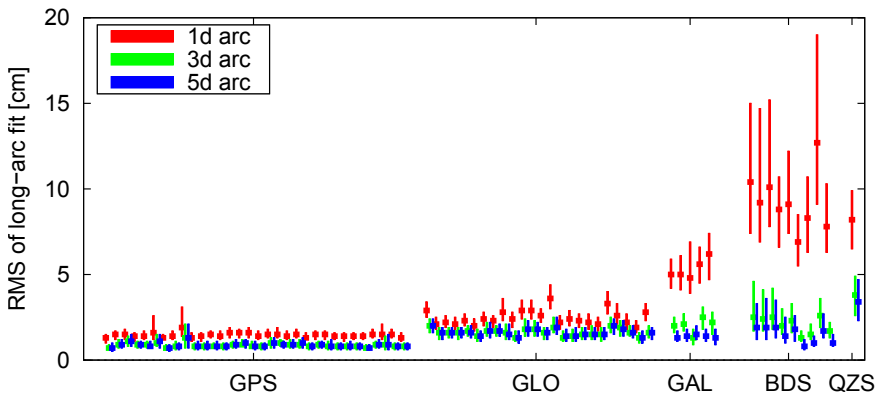

The multi-day long-arc solutions perform better than the one-day solutions for all satellites.

# Validation by Fitting Long Arcs

---



# Validation by Fitting Long Arcs

---

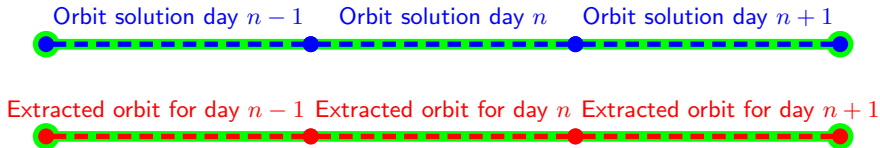

# Validation by Fitting Long Arcs

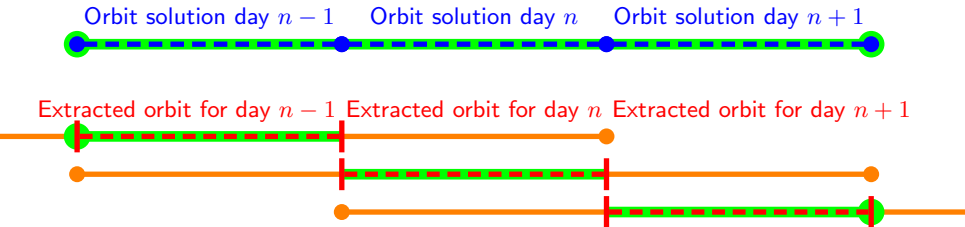



# Validation by Fitting Long Arcs

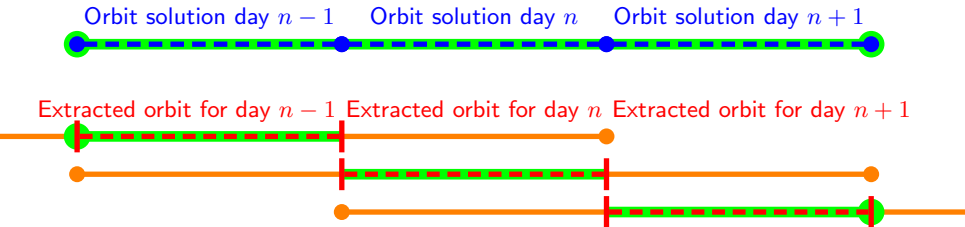

Disadvantage of the "Extracted orbit for day  $n$ " with respect to the direct "Orbit solution day  $n$ ":

- The orbits extracted from the three-day arc are not independent anymore.
- An orbit fit over several days cannot be used as a real quality indicator anymore.

# Validation by Orbit Overlaps

---

## 1. Fitting long arcs



## 2. Orbit overlaps



# Validation by Orbit Overlaps

## 1. Fitting long arcs



## 2. Orbit overlaps



# Validation by Orbit Overlaps

## CODE MGEX solution for the year 2015

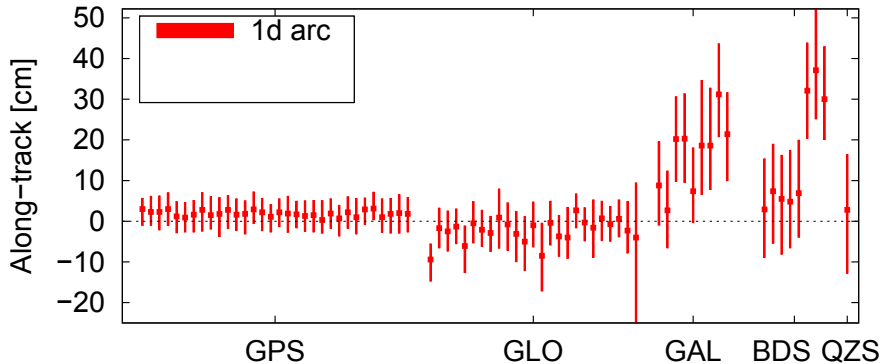

Median per satellite with associated quantiles

# Validation by Orbit Overlaps

## CODE MGEX solution for the year 2015

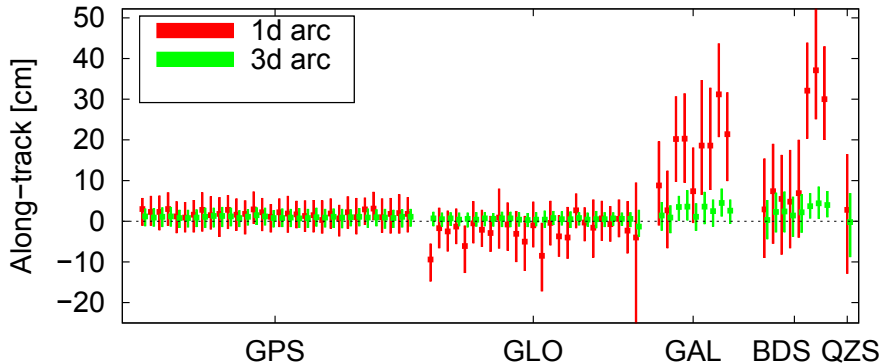

Median per satellite with associated quantiles

# Validation by Orbit Overlaps

## CODE MGEX solution for the year 2015

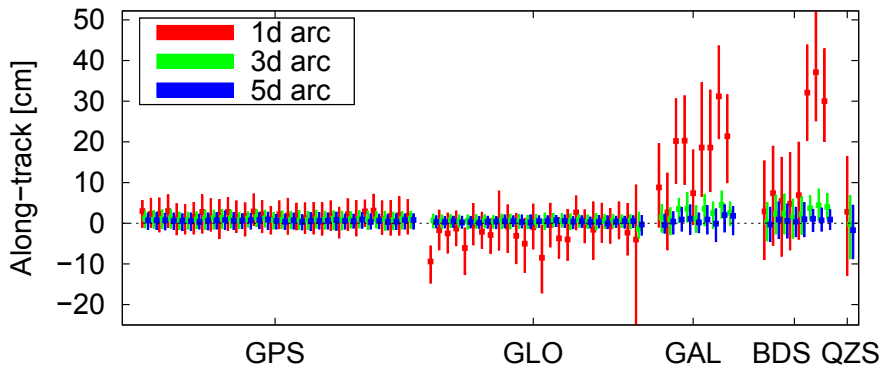

Median per satellite with associated quantiles

# Validation by Orbit Overlaps

## CODE MGEX solution for the year 2015

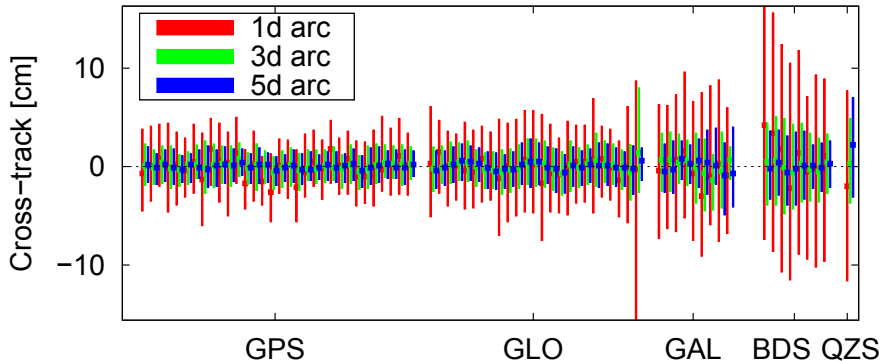

Median per satellite with associated quantiles

# Validation by Orbit Overlaps

## CODE MGEX solution for the year 2015

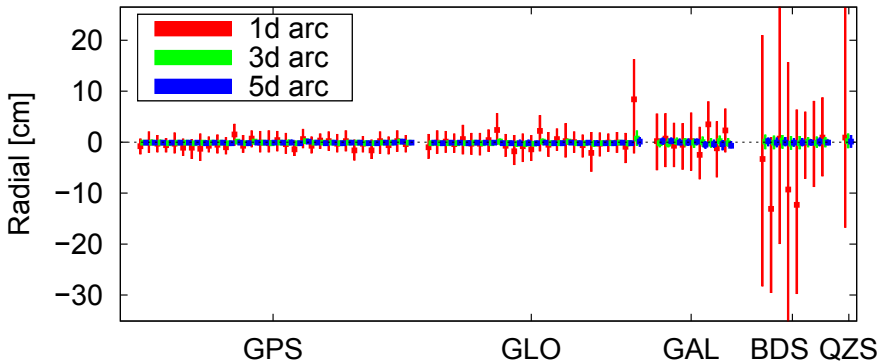

Median per satellite with associated quantiles



# Validation by Orbit Overlaps

---



# Validation by Orbit Overlaps

---

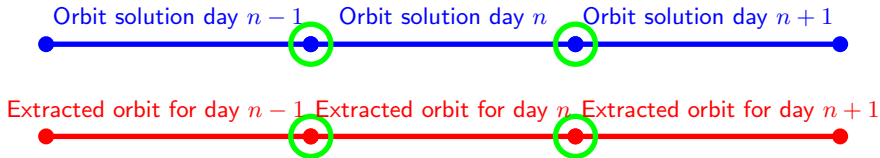

# Validation by Orbit Overlaps

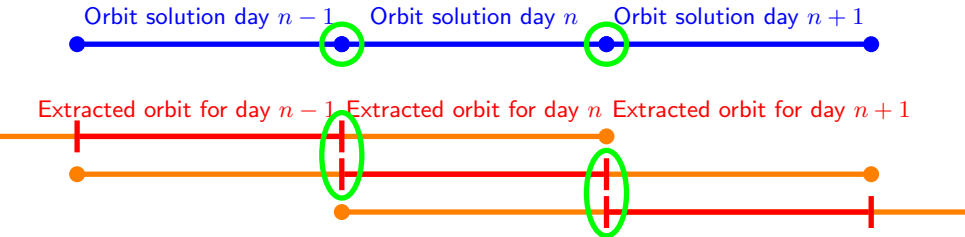

# Validation by Orbit Overlaps

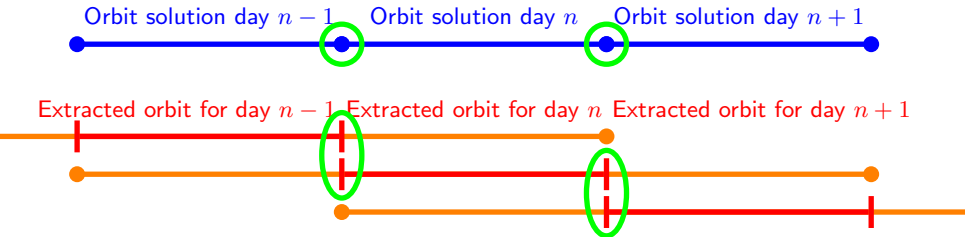

Disadvantage of the "Extracted orbit for day  $n$ " with respect to the direct "Orbit solution day  $n$ ":

- The orbits extracted from the three-day arc are not independent anymore.
- Day boundary discontinuities cannot be used as a real quality indicator anymore.

# Validation by SLR Measurements

---

## 1. Fitting long arcs



## 2. Orbit overlaps



## 3. Comparison with independent measurements (e.g., SLR)

- Consistency of the station coordinates between GNSS and SLR is required.
- Biases of both techniques need to be known.
- In case of problems an identification must be implemented to define which technique has caused the problem.

# Validation by SLR Measurements

## CODE MGEX solution (3d arc)

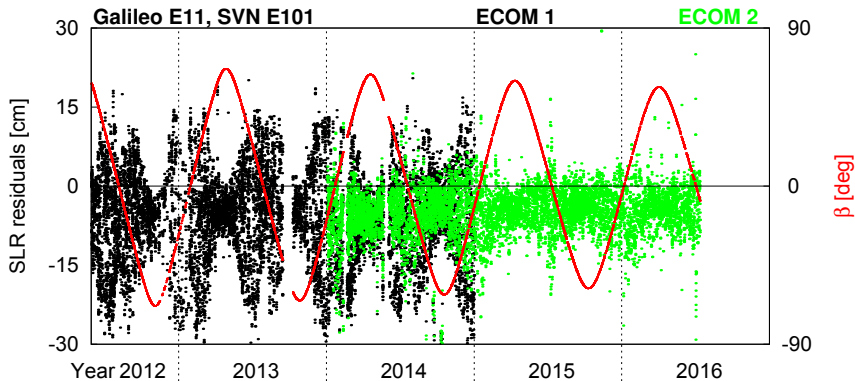

# Validation by SLR Measurements

## CODE MGEX solution (3d arc)

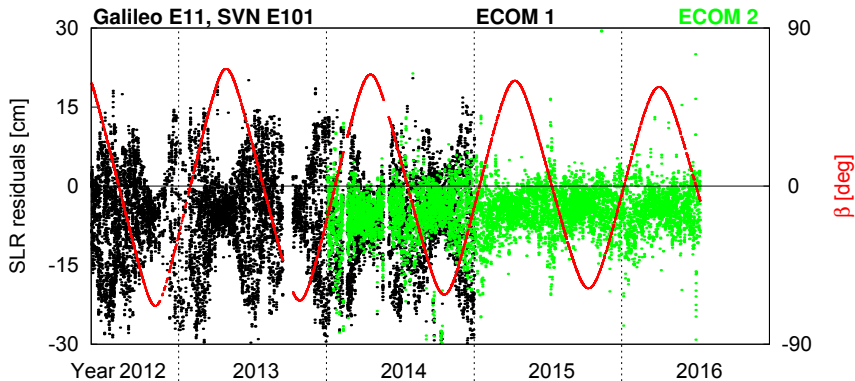

The new ECOM2 shows a clear improvement with respect to the old ECOM1 because of the stretched bodies of the Galileo satellites.

# Validation by SLR Measurements

## CODE MGEX solution (3d arc)

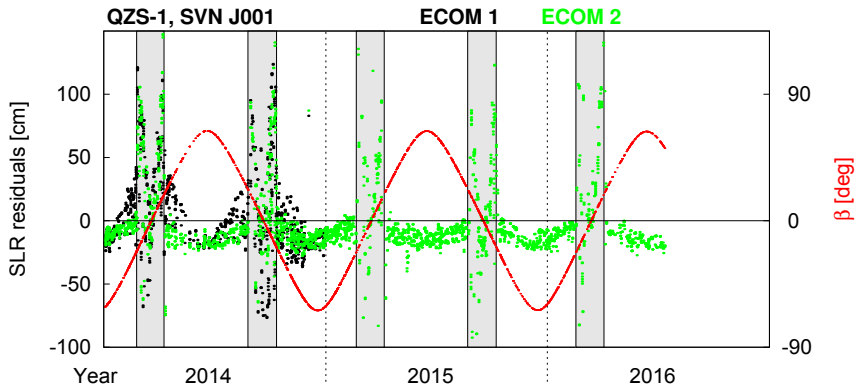

The new ECOM2 shows a clear improvement with respect to the old ECOM1 because of the stretched bodies of the QZSS satellites.



# Validation by SLR Measurements

## CODE MGEX solution (3d arc)

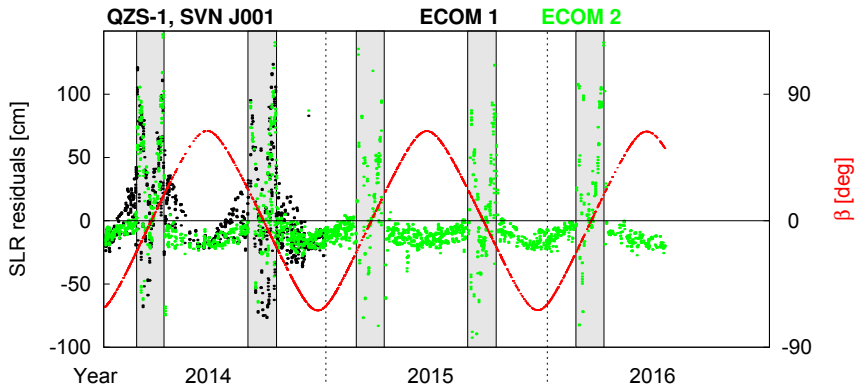

The ECOM2 decomposition is designed for the yaw-steering mode but not for the orbit normal mode.

# Validation by SLR Measurements

## CODE MGEX solution (3d arc)

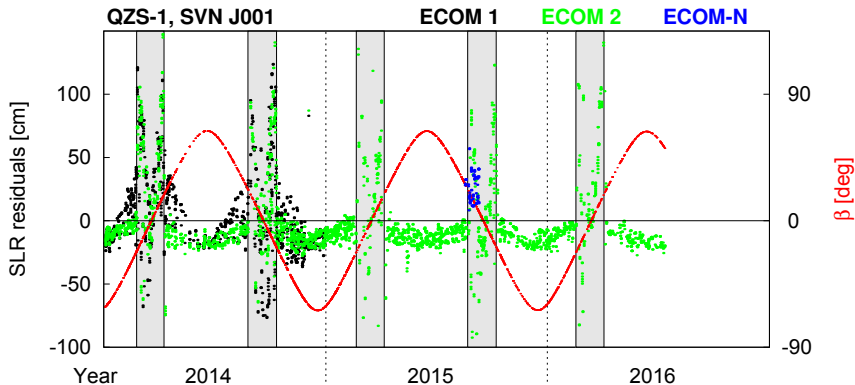

Alternative coordinate systems are needed for the empirical orbit parameters.

# Validation by SLR Measurements

## CODE MGEX solution (3d arc)

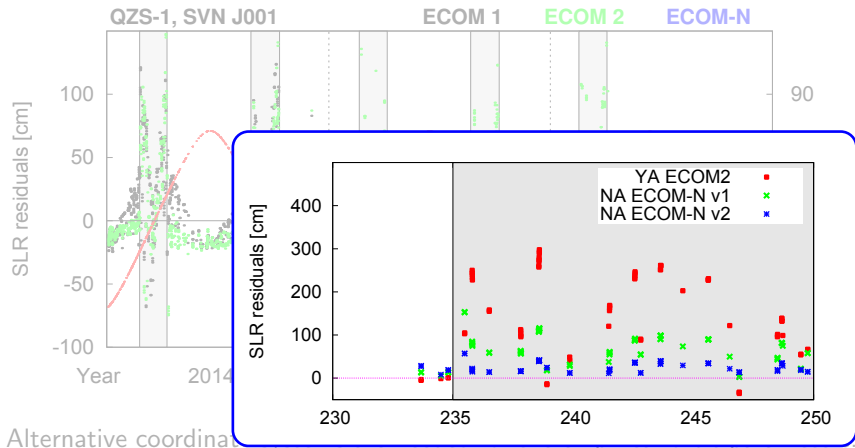

# Validation by Checking the Clock Performance

## 1. Fitting long arcs



## 2. Orbit overlaps



## 3. Comparison with independent measurements (e.g., SLR)

## 4. Checking the performance of the GNSS satellite clock

- Some of the GNSS satellites (Galileo, QZSS, GPS Block IIF) carry excellent clocks where a linear behaviour can be expected.
- Orbit modelling problems (mainly in the radial component) may map into estimated satellite clock values.

# Validation by Checking the Clock Performance

## CODE MGEX solution (3d arc)

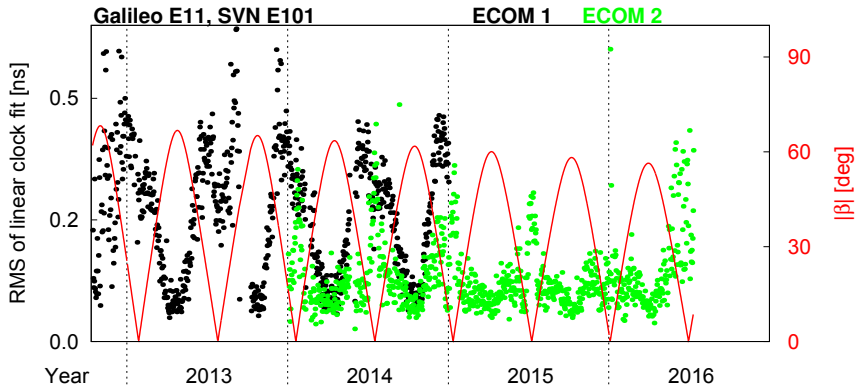

# Validation by Checking the Clock Performance

Clock corrections of Galileo PRN E11, SVN E101

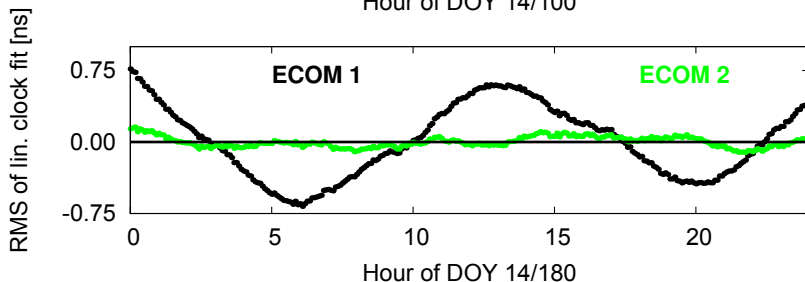
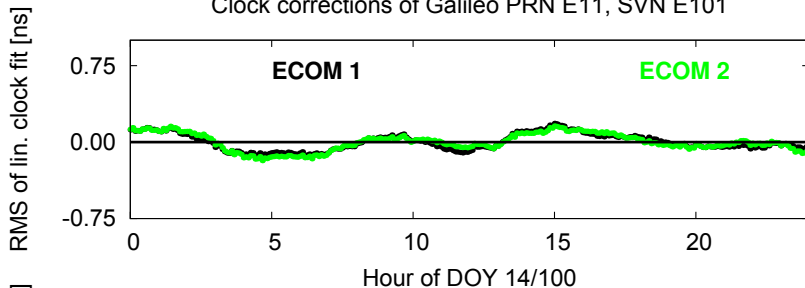

# Validation by Checking the Clock Performance

## CODE MGEX solution (3d arc)

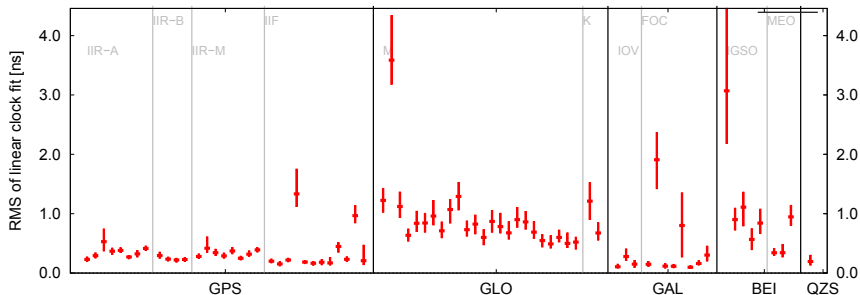

Median per satellite with associated quantiles

# Validation by Checking the Clock Performance

## CODE MGEX solution (3d arc)

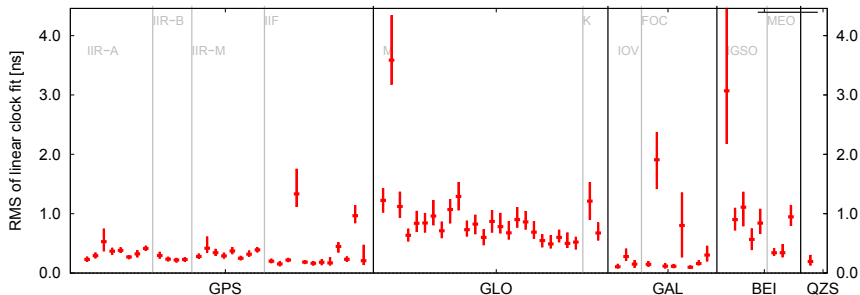

Median per satellite with associated quantiles

Not all GNSS satellite clocks perform well enough to serve for orbit validation purposes.



# Handling of Repositioning Events

---

- Constellation keeping: GPS, GEO and IGSO satellites
- GPS Block IIF satellites during the injection procedure

# Handling of Repositioning Events

---

- Constellation keeping: GPS, GEO and IGSO satellites
- GPS Block IIF satellites during the injection procedure

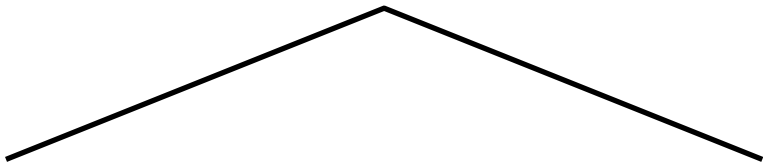

# Handling of Repositioning Events

---

- Constellation keeping: GPS, GEO and IGSO satellites
- GPS Block IIF satellites during the injection procedure

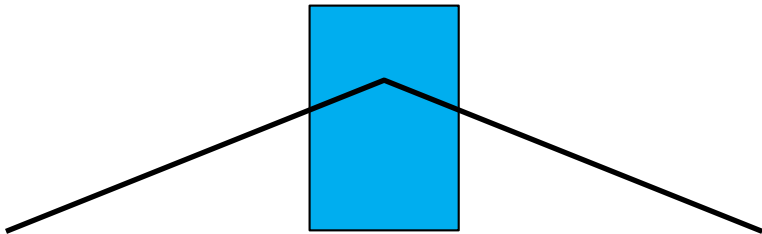

# Handling of Repositioning Events

---

- Constellation keeping: GPS, GEO and IGSO satellites
- GPS Block IIF satellites during the injection procedure

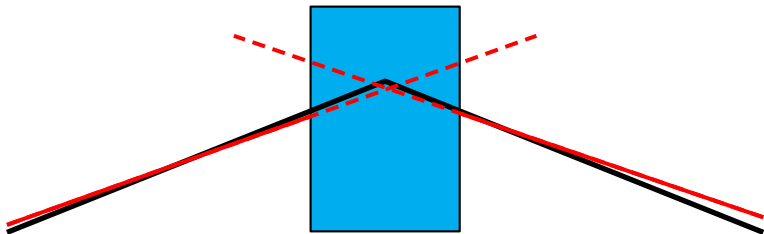

- Two independent satellite arcs are assumed (before and after the event)

# Handling of Repositioning Events

---

- Constellation keeping: GPS, GEO and IGSO satellites
- GPS Block IIF satellites during the injection procedure

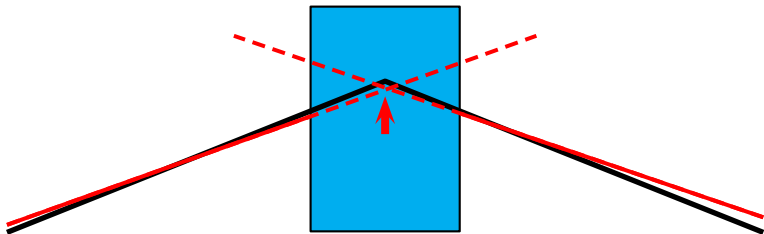

- Two independent satellite arcs are assumed (before and after the event)
- The smallest distance between both arcs gives the epoch and magnitude of the event.

# GPS Repositioning Events Estimated by CODE

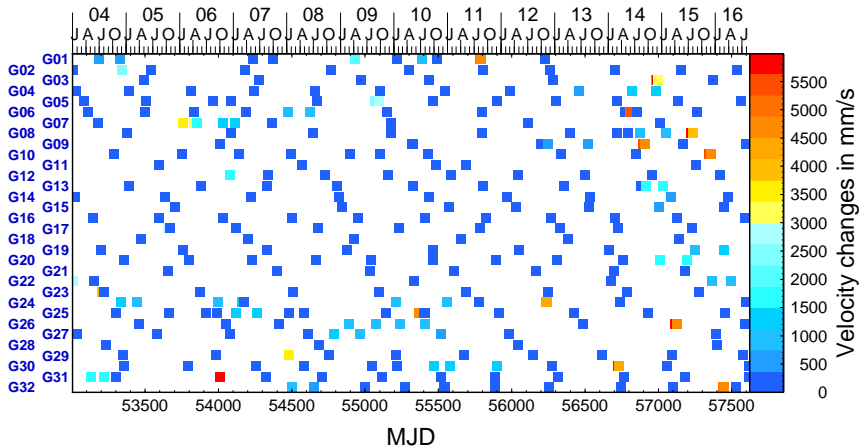

# GPS Repositioning Events Estimated by CODE

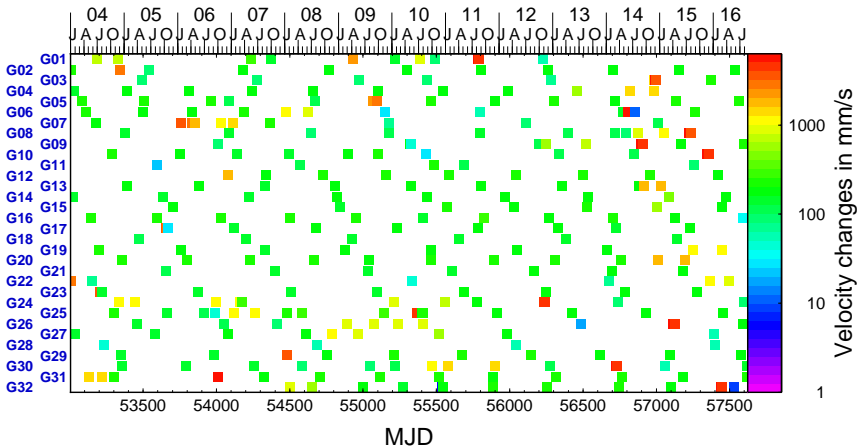

# GPS Repositioning Events Estimated by CODE

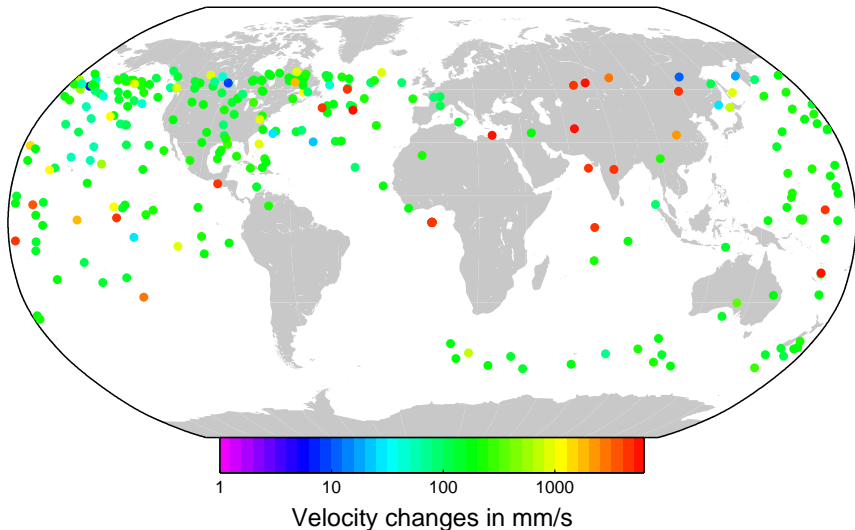

R. Dach: GNSS Satellite Orbit Modelling  
NGK Summer School, 29. Aug.–01. Sep. 2016, Bästäd



# GNSS Orbit Determination within the IGS

---

Introduction and Motivation

Overview on the GNSS Constellations

Effects Acting on Satellites and Related Models

Precise Orbit Determination for GNSS Satellites

GNSS Orbit Determination within the IGS

# The IGS – a Service of the IAG

---

**Precise GNSS satellite orbit determination is a challenging task** requiring a global solution based on a well distributed network of stations.

# The IGS – a Service of the IAG

---

**Precise GNSS satellite orbit determination is a challenging task** requiring a global solution based on a well distributed network of stations.

By 01. January 1994 the **IGS** was launched as an official service of the International Association of Geodesy (IAG).

# The IGS – a Service of the IAG

---

**Precise GNSS satellite orbit determination is a challenging task** requiring a global solution based on a well distributed network of stations.

By 01. January 1994 the **IGS** was launched as an official service of the International Association of Geodesy (IAG).

IGS means:

- International GPS Service for Geodesy and Geodynamics  
January 1994
- International GPS Service  
May 1998
- International GNSS Service  
March 2005

# The IGS and its Operational Orbit Products

---

**Final series** - ORB, ERP, CLK (300/30 sec. sampling), CRD

- available about two weeks after the end of the week
- GPS and GLONASS in compatible but independent series

**Rapid series** - ORB, ERP, CLK

- available at the day after the measurements, 17:00 UTC
- quality very close to the final products

**Ultra-rapid series** - ORB, ERP, (CLK, 300 sec. sampling)

- four updates per day, latency 3 hours
- contains 24 hours estimated and 24 hours predicted orbits
- GLONASS series on an experimental stage

# Combined IGS Products

---

Analysis  
Center 1

Analysis  
Center 2

Analysis  
Center 3

...

Analysis  
Center n

# Combined IGS Products

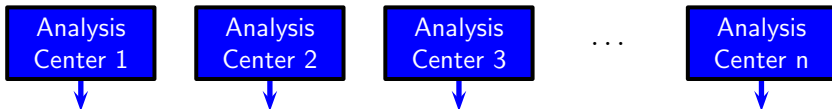

1. An unweighted mean orbit between the Analysis Centers is computed.

# Combined IGS Products

---

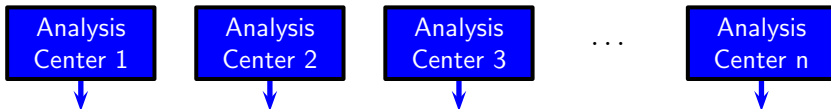

1. An unweighted mean orbit between the Analysis Centers is computed.
2. The standard deviation of each contribution to this mean orbit is computed to assign a weight to each Analysis Center.



# Combined IGS Products

---

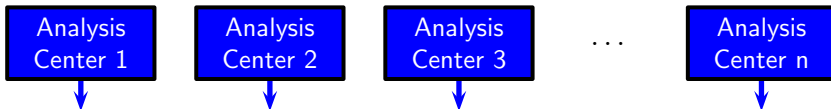

1. An unweighted mean orbit between the Analysis Centers is computed.
2. The standard deviation of each contribution to this mean orbit is computed to assign a weight to each Analysis Center.
3. The combined IGS orbit consists of the satellite positions computed as the weighted mean of the positions contributed by the Analysis Centers.

# Combined IGS Products

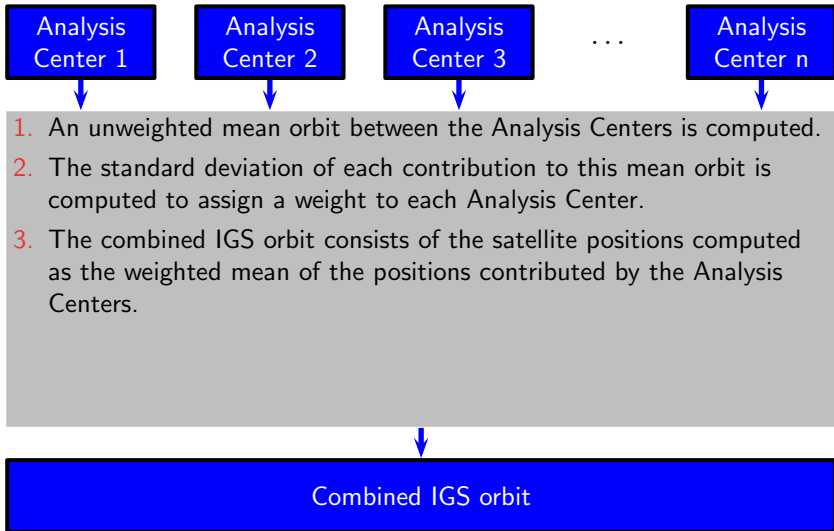

# Combined IGS Products

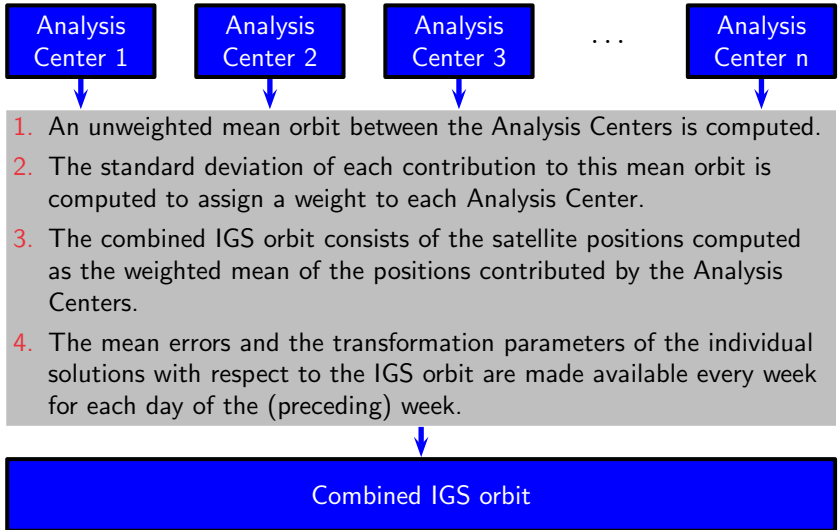

# Combined IGS Products

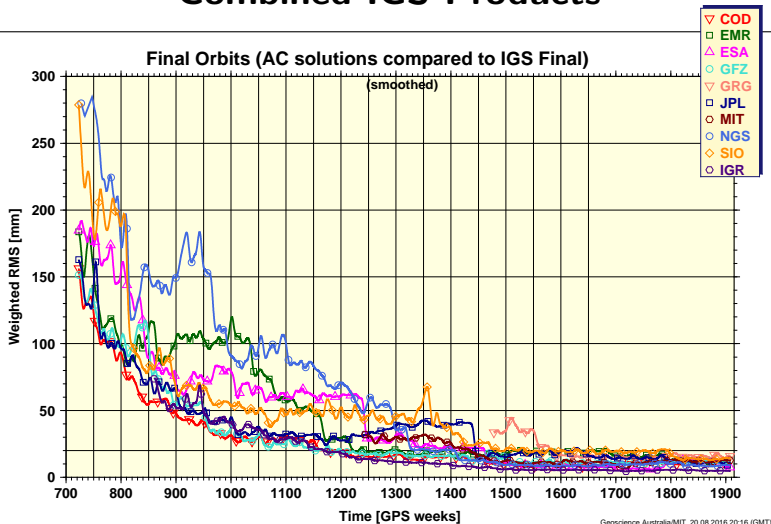

**Final Orbit** Quality from November 1993 – August 2016 as computed by the IGS Analysis Center Coordinator (smoothed weekly RMS values).

# Development of IGS Products

---

The **consistency** of the GNSS modelling between the individual Analysis Centers has **significantly been increased** during the last years.

# Development of IGS Products

---

The **consistency** of the GNSS modelling between the individual Analysis Centers has **significantly been increased** during the last years.

The biggest differences are currently in the GNSS satellite orbit modelling:

- All groups follow an empirical or semi-empirical approach where in most cases the parameters according to eqn. (4) are estimated.
- Significant differences exist in the a priori models that are introduced, e.g., for solar radiation pressure modelling.

# Development of IGS Products

---

The **consistency** of the GNSS modelling between the individual Analysis Centers has **significantly been increased** during the last years.

The biggest differences are currently in the GNSS satellite orbit modelling:

- All groups follow an empirical or semi-empirical approach where in most cases the parameters according to eqn. (4) are estimated.
- Significant differences exist in the a priori models that are introduced, e.g., for solar radiation pressure modelling.

Many Analysis Centers focus currently on the development of their **multi-GNSS processing capability**.

The IGS needs also a multi-GNSS capable **combination procedure**.

# Other Challenges

The GLONASS miracle:

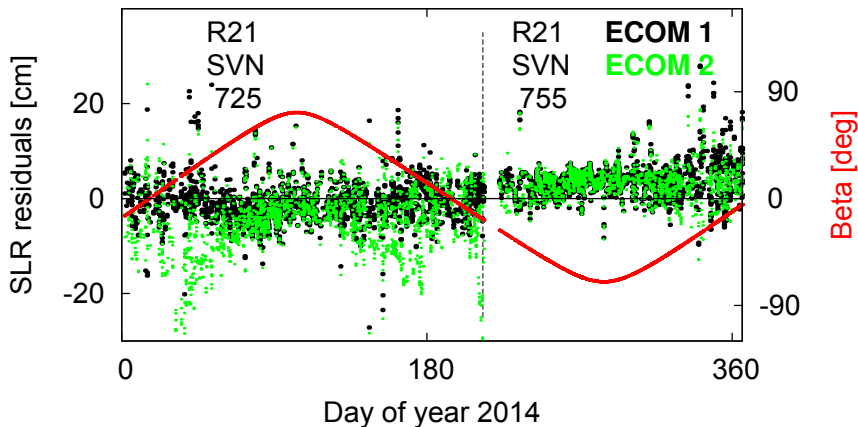

In the first part of the year the old ECOM1 outperforms the new ECOM2. This changes when a new satellite occupies the same slot in the constellation.



# Other Challenges

## The GLONASS miracle:

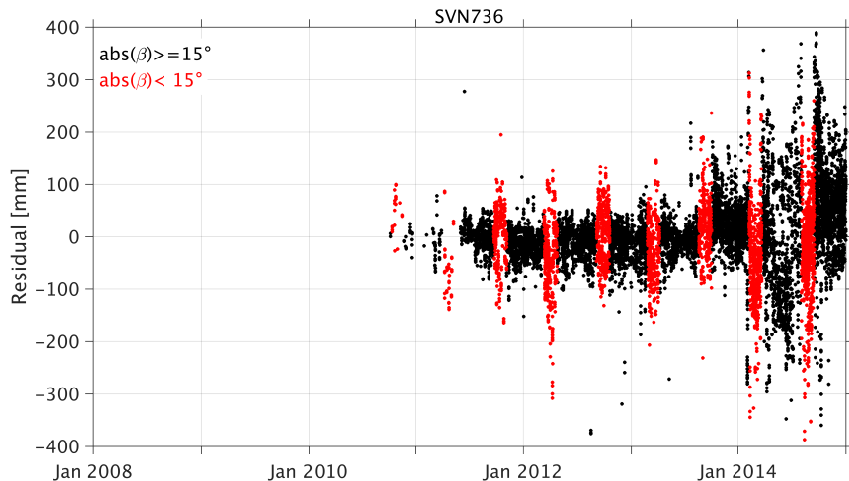

# Other Challenges

## The GLONASS miracle:

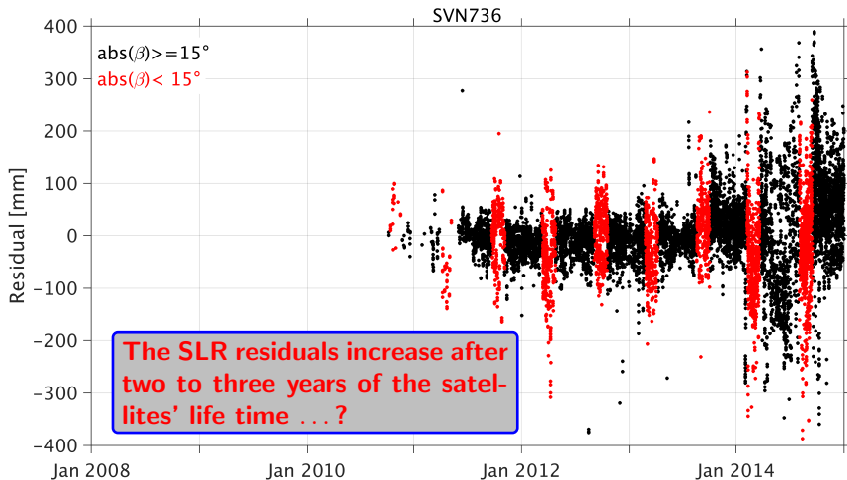

---

# THANK YOU

for your attention



Publications of the satellite geodesy research group:

<http://www.bernese.unibe.ch/publist>